

Beta

Action



Promotion valid until 28/02/2025
Prices do not include V.A.T.

£
2024

Beta

RECO50



**Configure
your workshop
in 3D online**

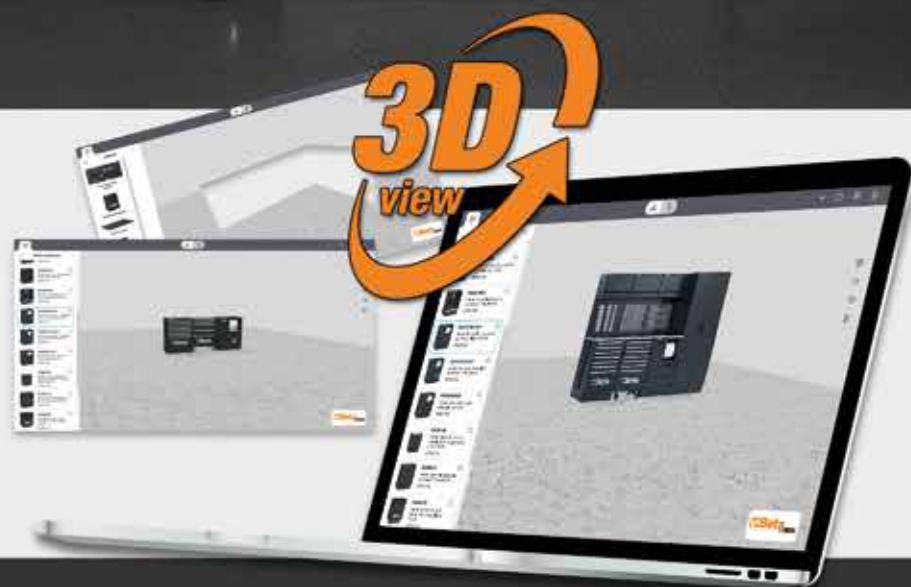

WORKSHOP EQUIPMENT C45PRO - RSC50 - RSC55

2÷4



CONTAINERS

5÷9



ASSORTMENT AND THERMOFORMED TRAYS

10÷14



WORKBENCHES

15



TROLLEYS AND BASKETS

16÷18



TOOL BAGS

19÷21

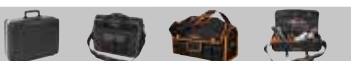

WRENCHES

22÷26



COLOR CODE ITEMS

26-27



SCREWDRIVERS

28-29



SOCKETS

30÷32



TORQUE WRENCHES

33-34



PLIERS

35÷37



DRILLING AND THREADING TOOLS

38-39



HAMMERS AND CHISELS

40



MEASURING TOOLS

41÷43



WELDING

44÷46



PLUMBING TOOLS

47



GENERAL MAINTENANCE TOOLS

48-49



LIGHTING AND REELS

50÷54



1000V INSULATED TOOLS

55-56



CUTTING TOOLS

57-58



POWER TOOLS

59-60



BETA ABRASIVES

61-62

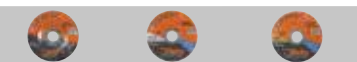

AUTOMOTIVE

63÷89



ROBUR

90-91



PNEUMATIC TOOLS

91÷97



SAFETY FOOTWEAR

98÷104



WORKWEAR

105÷111



BETA COLLECTION

112



The images are for reference only. Beta Utensili S.p.A. reserves the right to update and upgrade its product range without notice.



C45PRO

Workshop equipment combination C45PRO comprising:

- 1 fixed module with 7 drawers (C45PRO M7)
- 1 fixed service module (C45PRO MS)
- 1 mobile roller cab with 7 drawers (C45PRO C7)
- 1 two-door tool cabinet (C45PRO AS2)
- 3 perforated tool panels (C45PRO PF)
- 3 wall-mounted cabinets (C45PRO PM)
- 3 wall brackets, wide type (C45PRO SL)
- 1 wall bracket, narrow type (C45PRO SS)

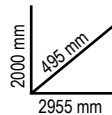

C45PRO X 045000001

~~£ 5.990,00~~ **£ 2.580,00**

- Worktop made of stainless steel coated MDF 2 m (C45PX/3-2,0MT)

 305 kg



C45PRO W 045000002

~~£ 5.840,00~~ **£ 2.510,00**

- Multi-ply wood worktop 2 m (C45PW/3-2,0MT)

 303 kg



C45PRO D

Workshop equipment combination C45PRO comprising:

- 1 fixed module with 7 drawers (C45PRO M7)
- 1 mobile roller cab with 7 drawers (C45PRO C7)
- 1 fixed service module (C45PRO MS)
- 1 fixed module with 5 drawers (C45PRO M5)
- 1 fixed module with 2 doors (C45PRO MA)
- 5 perforated tool panels (C45PRO PF)
- 5 wall-mounted cabinets (C45PRO PM)
- 7 wall brackets, wide type (C45PRO SL)
- 2 wall brackets, narrow type (C45PRO SS)
- 2 single-door tool cabinets (C45PRO AS1)

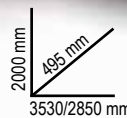

C45PRO DX 045000031

~~£ 11.650,00~~ **£ 5.010,00**

- 1 worktop made of stainless steel coated MDF 2 m (C45PX/3-2,0MT)
- 1 worktop made of stainless steel coated MDF 1,3 m (C45PX/2-1,3MT)
- 1 self-supporting complete corner with stainless steel coated MDF worktop (C45PRO CORNER/X)

 572 kg



C45PRO DW 045000032

~~£ 11.270,00~~ **£ 4.850,00**

- 1 multi-ply wood worktop 2 m (C45PW/3-2,0MT)
- 1 multi-ply wood worktop 1,3 m (C45PW/2-1,3MT)
- 1 self-supporting complete corner with wood worktop (C45PRO CORNER/W)

 568 kg



We at Beta keep investing in Italian-made production and are proud to **THE NEW WORKSHOP EQUIPMENT RANGE, RSC50**

NEW!

Beta
RSC50

Based on the expertise acquired with the two existing workshop equipment ranges, RSC55 and C45PRO, which allowed us to listen to and fully understand professional users' requirements, the project for the new range, RSC50, relies on the following pivotal concepts: **QUALITY, FUNCTIONALITY AND STURDINESS, EFFICIENCY, FLEXIBILITY and COMPATIBILITY**



RSC50 I 050001045 £ 21.970,00 **£ 9.450,00**

Workshop equipment combination RSC50 comprising:

- 1 2.240 mm worktop (RSC50 PG/3-2,2MT)
- 1 1.495 mm worktop (RSC50 PG/2-1,5MT)
- 1 fixed module with 7 drawers (RSC50 M7)
- 1 mobile roller cab with 7 drawers (RSC50 C7)
- 1 fixed service module with 2 drawers (RSC50 MS-2C)

- 1 self-supporting complete corner (RSC50 AC-G)
- 1 fixed module with 5 drawers (RSC50 M5)
- 1 fixed two-door module (RSC50 MA)
- 5 wall-mounted cabinets (RSC50 PM)
- 5 upper perforated tool panels (RSC50 PFS)
- 5 lower perforated tool panels (RSC50 PFI)
- 5 pairs of right/left uprights (RSC50 P/2MDX-SX)
- 2 single-door cabinets (RSC50 A1)

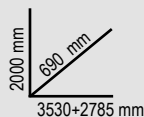

625 kg



RSC50 F 050001030 £ 12.560,00 **£ 5.400,00**

Workshop equipment combination RSC50 comprising:

- 1 2.240 mm worktop (RSC50 PG/3-2,2MT)
- 1 fixed module with 7 drawers (RSC50 M7)
- 1 mobile roller cab with 7 drawers (RSC50 C7)
- 1 fixed service module with 2 drawers (RSC50 MS-2C)
- 3 wall-mounted cabinets (RSC50 PM)
- 3 upper perforated tool panels (RSC50 PFS)
- 3 lower perforated tool panels (RSC50 PFI)
- 3 pairs of right/left uprights (RSC50 P/2MDX-SX)
- 1 two-door cabinet (RSC50 A2)

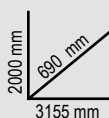

361 kg





C55PB-PRO/9A

055000067

£ 16.890,00 **£ 7.266,00**

NEW!

Workstation for workshop equipment combination RSC55

Combination comprising:

C55B/2.8

Workbench with worktop 2850x700 mm covered with a shockproof, nonscratch, ABS coat resistant to oil and hydrocarbons.

C55M7

Fixed module with seven drawers (588x367 mm), with ball bearing slides

C55MA

Fixed two-door module

C55M4

Fixed module with four drawers (588x367 mm), with ball bearing slides

C55PM + C55PT1,0x0.6 + C55/PF

- 2 suspended cabinets (1024x400x300 mm) fitted with gas springs

- 2 under-cabinet panels (1024x620x25 mm)

- 2 perforated under-cabinet tool panels (1024x620x25 mm)

C55PM/M0.8 + C55PT0.8x0.6 + C55/1PF

- 1 suspended cabinet (800x400x300 mm) fitted with gas springs

- 1 under-cabinet panel (800x620x25 mm)

- 1 perforated under-cabinet tool panel (800x620x25 mm)

C55A2

- 1 two-door tool cabinet



535 kg

2000 mm
760 mm
3650 mm

C55PB-PRO/10

055000068

£ 15.360,00 **£ 6.930,00**

NEW!

Workstation for workshop equipment combination RSC55

Combination comprising:

C55B/2.8

Workbench with worktop 2850x700 mm covered with a shockproof, nonscratch, ABS coat resistant to oils and hydrocarbons.

C55MS

Fixed service module

C55C7

Mobile roller cab with seven drawers (588x367 mm), with ball bearing slides

C55M7

Fixed module with seven drawers (588x367 mm), with ball bearing slides

C55PM + C55PT1,0x0.6 + C55/PF

- 2 suspended cabinets (1024x400x300 mm) fitted with gas springs

- 2 under-cabinet panels (1024x620x25 mm)

- 2 perforated under-cabinet tool panels (1024x620x25 mm)

C55PM/M0.8 + C55PT0.8x0.6 + C55/1PF

- 1 suspended cabinet (800x400x300 mm) fitted with gas springs

- 1 under-cabinet panel (800x620x25 mm)

- 1 perforated under-cabinet tool panel (800x620x25 mm)



467 kg

2000 mm
760 mm
2850 mm

C37

Mobile roller cab

- Sturdy multi-purpose worktop
- Quick release system made of aluminium, opening throughout length of drawer
- **Corner bumpers** throughout height of roller cab, to avoid damaging vehicles in garage
- 4 castors Ø 125 mm: 2 fixed and 2 steering (one with brake)
- Tote-trays and holes for accommodating screwdrivers
- Built-in side bottle and paper holders, adjustable in several positions

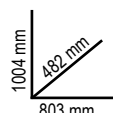

71 kg



	Ral 2011	Ral 7016	Ral 3000	n°	Max	kg	£
C37/6	037000061	037000062	037000063	4	75 mm	30 kg	£ 1.530,00 £ 660,00
				1	150 mm	35 kg	
				1	305 mm	40 kg	
C37/7	037000071	037000072	037000073	5	75 mm	30 kg	£ 1.575,00 £ 675,00
				1	150 mm	35 kg	
				1	225 mm	35 kg	
C37/8	037000081	037000082	037000083	6	75 mm	30 kg	£ 1.635,00 £ 705,00
				2	150 mm	35 kg	

C37A/7

Mobile roller cab with 7 drawers WITH ANTI-TILT SYSTEM



n°	Max	kg
5	75 mm	30 kg
1	150 mm	35 kg
1	225 mm	35 kg



Ral 2011	Ral 7016	Ral 3000
037000271	037000272	037000273
£ 1.690,00	£ 725,00	

C39

Mobile roller cab

- Sturdy multi-purpose worktop with tote-trays and holes for accommodating screwdrivers
- 4 castors with steel cores, Ø 125 mm: 2 fixed and 2 steering (one with brake)
- Front centralized safety lock
- Pull-out drawer with opening system throughout its length
- Built-in side and rear bottle and paper holders



UPRIGHTS AND DRAWER FRONT MADE OF ALUMINIUM ALLOY + STURDINESS + LIGHTWEIGHTNES

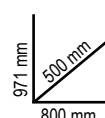

	Ral 2011	Ral 7016	Ral 3000	n°	Max	kg	£
C39/6	039000031	039000032	039000033	4	70 mm	30 kg	£ 2.175,00 £ 1.090,00
				1	140 mm	35 kg	
				1	280 mm	40 kg	
C39/7	039000001	039000002	039000003	5	70 mm	30 kg	£ 2.300,00 £ 1.150,00
				1	140 mm	35 kg	
				1	210 mm	35 kg	
C39/8	039000041	039000042	039000043	6	70 mm	30 kg	£ 2.630,00 £ 1.315,00
				2	140 mm	35 kg	

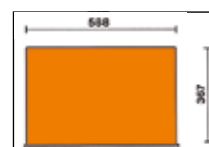

THE EVOLUTION OF PERFECTION! DISCOVER THE RSC RANGE!



The RSC range has been designed to satisfy all professionals' requirements and ensure reliability as well as high operation performance. The innovative design, inspired by the racing world, provides these mobile roller cabs and trolleys with a captivating, unique style: the 7 colours and its finish make the RSC range synonymous with one-of-a-kind products in the market. The sturdy frameworks and the materials result in high quality and remarkable durability, thereby effectively supporting the daily work of industrial production departments, mechanics, car body repairers and general maintenance service providers. What is more, most RSC roller cabs are TÜV certified. This prestigious certification - which is the name for safety and guaranteed quality - is obtained upon successful completion of severe tests under the EK5/TA5 protocol.



RSC24

Mobile Roller cab

- ABS reinforced worktop
- Multi-purpose top with anti-fall edges and eight holes for accommodating screwdrivers
- Drawer bases protected by foamed rubber mats
- 4 castors Ø 125 mm: 2 fixed and 2 steering (one with brake)
- Each drawer can accommodate **up to 4 EVA foam or ABS thermoformed trays**
- Front centralized safety lock
- Static load capacity: 800 kg
- Built-in bottle holder (can be applied on both sides).



The following accessories can be added:

- Wood worktop 2400 RSC24/PL
- Perforated tool panel 2400 RSC24/PF
- Folding shelf 2400 RSC24/MP
- Document holder 2400 RSC24/PD
- Paper roll holder 2400 RSC24/PC
- Computer wall bracket 2400 RSC24/SPC



	Ral 2011	Ral 2011 Ral 7016	Ral 9006 Ral 7016	Ral 3000 Ral 7016	Ral 5015 Ral 7016	Ral 7016	Ral 9005	kg	£
RSC24/5	024004050	024004051	024004052	024004053	024004056	024004057	024004059	60	£ 1.181,00 £ 499,00
RSC24/6	024004060	024004061	024004062	024004063	024004066	024004067	024004069	62	£ 1.205,00 £ 520,00
RSC24/7	024004070	024004071	024004072	024004073	024004076	024004077	024004079	63	£ 1.235,00 £ 557,00
RSC24/8	024004080	024004081	024004082	024004083	024004086	024004087	024004089	66	£ 1.295,00 £ 583,00

RSC24/5		
n°	Max	kg
2	70 mm	25 kg
2	140 mm	30 kg
1	280 mm	35 kg

RSC24/6		
n°	Max	kg
4	70 mm	25 kg
1	140 mm	30 kg
1	280 mm	35 kg

RSC24/7		
n°	Max	kg
5	70 mm	25 kg
1	140 mm	30 kg
1	210 mm	30 kg

RSC24/8		
n°	Max	kg
6	70 mm	25 kg
2	140 mm	30 kg

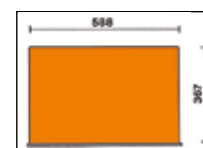

RSC24AXL

Mobile roller cab, WITH ANTI-TILT SYSTEM, long model

- New ABS reinforced worktop with anti-fall edges, eight holes for accommodating screwdrivers and 6 tote trays
- **Sturdy nylon front, with built-in label holder.**
- Drawer bases protected by foamed rubber mats
- 4 castors, Ø 125 mm: 2 fixed and 2 steering (one with brake)
- Front centralized safety lock
- Built-in side bottle holder (can be applied on both sides)
- Each drawer can accommodate **up to 6 EVA foam or ABS thermoformed trays**

Following accessories can be added:

- Wood worktop 2400 RSC24/PL
- Document holder 2400 RSC24/PD-A
- Paper roll holder 2400 RSC24/PC-A

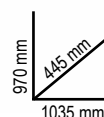

	Ral 2011 Ral 7016	Ral 3000 Ral 7016	Ral 7016	n° ↓ max	kg	£
RSC24AXL/7	024004271	024004273	024004277	5 70 mm 30 kg 1 140 mm 35 kg 1 210 mm 35 kg	84	£ 1.530,00 £ 740,00
RSC24AXL/8	024004281	024004283	024004287	6 70 mm 30 kg 2 140 mm 35 kg	88	£ 1.655,00 £ 798,00
RSC24AXL/9	024004291	024004293	024004297	8 70 mm 30 kg 1 140 mm 35 kg	90	£ 1.725,00 £ 835,00

RSC24L/7

Mobile roller cab with 7 drawers and side shelves

- 7 drawers (588x367 mm) with ball bearing slides
- Drawer bases protected by foamed rubber mats
- 4 castors, Ø 125 mm: 2 fixed and 2 steering with brakes
- Front centralized lock
- Multi-ply wood worktop with holes for a vice (1599F/100 - 1599GI/100, to be ordered separately)
- **Side compartment with vertically adjustable shelf**
- Built-in paper roll holder
- Double rear bottle holder

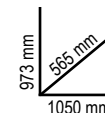

80 kg



	Ral 2011 Ral 7016	Ral 3000 Ral 7016	Ral 7016
	024004371	024004373	024004377
	£ 1.790,00	£ 770,00	

n°	↓ Max
5	70 mm 25 kg
1	140 mm 30 kg
1	210 mm 30 kg



RSC24AXLP/7

NEW!

Mobile roller cab with 7 drawers, with wood worktop and ANTI-TILT SYSTEM, long model

- Long model with 7 fully removable drawers (882x367 mm), with ball bearing slides
- Multi-ply wood worktop with holes for a vice 1599F/100 or 1599GI/100 (to be ordered separately)
- Sturdy nylon front, with built-in label holder
- Drawer bases protected by foamed rubber mats
- 4 castors, Ø 125 mm: 2 fixed and 2 steering (one with brake)
- Front centralized safety lock
- Built-in side bottle holder (can be applied on both sides)
- Built-in paper roll holder
- Each drawer can accommodate up to 6 EVA foam or ABS thermoformed trays

Following accessories can be added:

- Perforated tool panel with supports 2400 RSC24AXLP/PF
- Computer bracket 2400 RSC24/SPC
- Side tool tray 2400 RSC24AXLP/VL
- Waste bin 2400 RSC24AXLP/CPR
- Folding side shelf 2400 RSC24/MP



Ral 2011	Ral 3000	Ral 7016
Ral 7016	Ral 7016	Ral 7016
024004571	024004573	024004577
£ 2.830,00	£ 919,00	

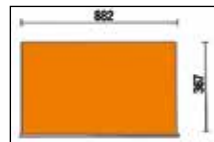

n°	Height	Max Weight
5	70 mm	30 kg
1	140 mm	35 kg
1	210 mm	35 kg

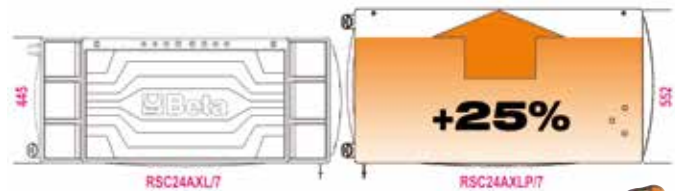

kg
1100



RSC28

SuperTank trolley with wood worktop and 10 drawers

- 10 drawers (588x367 mm) with ball bearing slides
- Quick, safe system for opening and closing drawers, with nylon and fibreglass front
- **5 side drawers:**
 - 4 drawers, 70 mm high
 - 1 drawer, 210 mm high
- **5 front drawers:**
 - 4 drawers, 70 mm high
 - 1 drawer, 210 mm high
- Drawer bases protected by foamed rubber mats.
- 4 high-capacity castors, Ø 150 mm: 2 fixed and 2 steering with brakes
- 2 centralized safety locks
- 3 front tool drawers
- Multi-ply wood worktop with holes for a vice (1599F/150 - 1599GI/150, to be ordered separately)
- Built-in tool compartment



Ral 2011	Ral 3000	Ral 7016
Ral 7016	Ral 7016	Ral 7016
028003001	028003003	028003007
£ 3.290,00	£ 1.481,00	



n°	Height	Max Weight
8	70 mm	25 kg
2	210 mm	30 kg

kg
1200



- Side compartment with foldaway door with lock
- Built-in bottle holders
- 135-mm-high storage compartment with plastic-covered base



RSC51

Service tool trolley with 3 drawers

- 3 drawers (588x367 mm) with ball bearing slides, 70 mm high
- ABS reinforced worktop, solid and sturdy
- Multipurpose top with anti-fall edges and 8 holes for accommodating screwdrivers
- Drawer bases protected by foamed rubber mats
- Each drawer can accommodate up to 4 EVA foam or ABS thermoformed trays
- Front centralized safety lock
- Convenient side screwdriver holder included
- Two built-in side spray can holders
- Large lower shelf protected by an anti-oil and anti-petrol rubber mat
- 4 castors, Ø 125 mm: 2 fixed castors and 2 swivel castors (one with brake)
- Static load capacity: 400 kg
- Capacity of each drawer: 15 kg, evenly distributed



Ral 2011	Ral 3000	Ral 7016
051000300	051000303	051000307
£ 685,00	£ 331,00	

588		367
[Orange square]		
n°	Max	
3	70 mm	15 kg

COMPLETELY CHANGED AND CUSTOMIZABLE WITH ACCESSORIES!

Following accessories can be added:

- Wood worktop 2400 RSC24/PL
- Perforated tool panel 2400 RSC24/PF
- PC support 2400 RSC24/SPC
- Folding shelf 2400 RSC24/MP
- Paper roll holder 2400 RSC24/PC-A



A MUST-HAVE FOR YOUR GARAGE!

C04TSS/7

024003077

£ 3.740,00 **£ 1.610,00**

Mobile roller cab with 7 drawers

MADE OF STAINLESS STEEL

- 7 drawers (570 x 410 mm) with ball bearing slides.
- 4 castors Ø 125 mm
- 2 fixed and 2 steering (two with brakes)
- Front centralized lock
- Frame made entirely of stainless steel AISI 304
- Castors, supports, ball bearings, drawer interiors and guides made of stainless steel
- Drawer handles made of aluminium



570		410
[Stainless steel square]		

n°	Max	
6	83 mm	25 kg
1	170 mm	30 kg

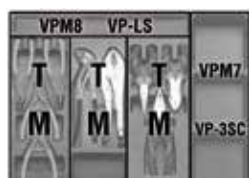

NON-MARKING WHEELS





5988VU/M

059880356

£ 3.740,00 £ 1.610,00

Assortment of 214 tools in soft foam tray

Recommended with: RSC24 - RSC24A - RSC24AXL - RSC24AXLP/7 - C37 - C39 - C39SM - C39MD - RSC28 - C59 - RSC50 - RSC55



Quantity/Description	Beta N.	TR
22 combination wrenches 6-7-8-9-10-11-12-13-14-15-16-17-18-19-20-21-22-24-27-30-32-36 mm	42	M01
11 double open end wrenches 6x7-8x9-10x11-12x13-14x15-16x17-18x19-20x22-21x23-24x27-30x32 mm	55	M30
11 double ended offset ring wrenches 6x7-8x9-10x11-12x13-14x15-16x17-18x19-20x22-21x23-24x27-30x32 mm	90	M30
9 ball head offset hexagon key wrenches \varnothing 1,5+10 mm	96BPC/SC9	M30
1 socket holder	895/1	M100
1 socket holder	895/3	M100
1 socket holder	895/6	M100
13 1/4" hexagon sockets \varnothing 4-4,5-5-5,5-6-7-8-9-10-11-12-13-14 mm	900	M100
9 hexagon hand sockets, long series \varnothing 5-6-7-8-9-10-11-12-13 mm	900L	M100
5 1/4" socket drivers for hexagon screws \varnothing 3-4-5-6-7 mm	900ME	M100
4 socket drivers for slotted head screws \bullet 0,8x4-1x5,5-1,2x6,5-1,2x8 mm	900LP	M100
4 socket drivers for cross head Phillips® screws \bullet PH1-PH2-PH3-PH4	900PH	M100
7 socket drivers for Torx® head screws \varnothing T10-T15-T20-T25-T27-T30-T40	900TX	M100
1 1/4" drive extension bar 50 mm	900/20	M100
1 1/4" drive extension bar 100 mm	900/20L	M100
1 1/4" drive extension bar 150 mm	900/21	M100
1 1/4" drive universal joint	900/25	M100
1 1/4" drive spinner handle	900BG/30	M100
1 1/4" drive swivel T-handle	900/42	M100
1 1/4" reversible ratchet \otimes	900/55	M100
21 1/2" square drive hexagon sockets \varnothing 8-10-11-12-13-14-15-16-17-18-19-20-21-22-23-24-26-27-28-30-32 mm	920A	M100
1 adaptor, 1/2" female and 3/8" male drives 125 mm	920/15	M100
1 1/2" drive universal joint 250 mm	920/25	M100
1 1/2" wobble extension bar 125 mm	920AN/125	M100
1 1/2" wobble extension bar 250 mm	920AN/250	M100
1 1/2" drive sliding T-handle 305 mm	920/42	M100
1 1/2" drive reversible ratchet \otimes	920/55	M100
8 1/2" sockets for Torx® head screws \varnothing 10-12-14-16-18-20-22-24 mm	920FTX	M100
11 hexagon hand sockets \varnothing 10-12-13-14-15-16-17-18-19-21-22 mm	920AL	M100
1 circlip pliers straight, internal \varnothing 180 mm	1032	M129
1 circlip pliers bent, internal \varnothing 170 mm	1034	M129
1 circlip pliers straight, external \bullet 175 mm	1036	M129
1 circlip pliers bent, external \bullet 175 mm	1038	M129
1 slip joint pliers 250 mm	1048N	M129
1 self - locking pliers 240 mm	1052	M129
1 Diagonal cutting nippers \nless 160 mm	1082BM	M129
1 construction worker's pincers 220 mm	1098	M129
1 tin snips 250 mm	1112	M129
1 electrician's scissors, straight blades	1128BM	M129
1 half-round needle nose pliers \equiv 180 mm	1150BM	M129
1 Extra-long needle nose pliers \bullet 160 mm	1166BM	M129
1 Extra-long bent needle nose pliers \bullet 160 mm	1168BM	M129
6 screwdriver for slotted head screws \bullet 2,5x50-3x75-4x100-5,5x125-6,5x150-8x200 mm	1201E	M213
1 screwdriver for slotted head screws, extra-short series \bullet 4x30 mm	1201EN	M213
4 screwdriver for cross head Phillips® screws \bullet PH0,60-PH1x80-PH2x100-PH3x150 mm	1202E	M213



M01

M30

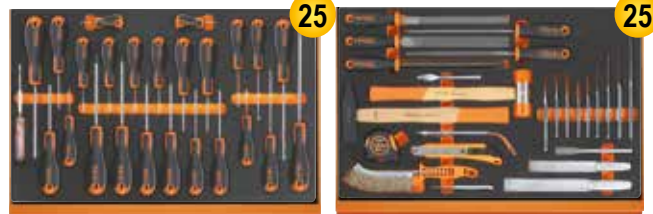

M213

M230



M129

M100

- 1 screwdriver for cross head Phillips® screws, extra-short series \bullet PH1x30 mm 1202EN M213
- 12 screwdrivers for Torx® head screws, with handles \varnothing T6-T7-T8-T9-T10-T15-T20-T25-T27-T30-T40-T45" 1207E/TX M213
- 1 mains testing screwdriver \bullet 1253 M213
- 3 drift punches 2-3-4 mm 30 M230
- 6 pin punches 2-3-4-5-6-8 31 M230
- 1 centre punch \varnothing 4 mm 32 M230
- 1 flat chisels 150 mm 34 M230
- 2 flat chisels, ribbed type 200-250 mm 35 M230
- 1 cape chisels, standard type 125 mm 36 M230
- 1 engineer's hammer 500 g 1370 M230
- 1 soft face hammer \varnothing 35 mm 1390 M230
- 1 measuring tape 3 m 1692 M230
- 1 telescopic magnet with flexible head 1712TF M230
- 1 second-cut square files 200 mm 1719BMA...Q M230
- 1 second-cut triangular files 200 mm 1719BMA...T M230
- 1 second-cut flat files 200 mm 1719BMA...P M230
- 1 second-cut half-round files 200 mm 1719BMA...M M230
- 1 second-cut round files 200 mm 1719BMA...R M230
- 1 steel wire brush 1737NX M230
- 1 snap - off blade utility knife 18 mm 1771 M230

5904VA/T

059040416

£ 2.120,00 £ 910,00

Assortment of 102 tools in ABS

Quantity/Description	Beta N.	TR
21 combination wrenches 6-7-8-9-10-11-12-13-14-15-16-17-18-19-20-21-22-24-27-30-32 mm	42	T05 +T06
8 double open end wrenches 6x7-8x9-10x11-12x13-14x15-16x17-18x19-20x22 mm	55	T33
9 offset hexagon key wrenches \varnothing 1,5+10 mm	96/SC9	T33
6 offset hexagon key wrenches \varnothing 2-2,5-3-4-5-6 mm	96T	T52
8 T - handle wrenches with swivelling socket \varnothing 7-8-10-12-13-14-17-19 mm	952	T63
19 1/2" square drive hexagon sockets \varnothing 10-11-12-13-14-15-16-17-18-19-20-21-22-23-24-26-27-30-32 mm	920A	T83
1 1/2" drive extension bar 125 mm	920/21	T83
1 1/2" drive extension bar 255 mm	920/22	T83
1 1/2" drive universal joint	920/25	T83
1 1/2" drive sliding T-handle 305 mm	920/42	T83
1 1/2" drive reversible ratchet \otimes	920/55	T83
1 heavy-duty diagonal cutting nippers \nless 160 mm	1084BM	T137
1 half-round needle nose pliers \equiv 180 mm	1150BM	T137
1 extra-long needle nose pliers \bullet 160 mm	1166BM	T137
1 circlip pliers straight, internal \varnothing 180 mm	1032	T145
1 circlip pliers bent, internal \varnothing 170 mm	1034	T145
1 circlip pliers straight, external \bullet 175 mm	1036	T145
1 circlip pliers bent, external \bullet 175 mm	1038	T145
1 self - locking pliers 240 mm	1052	T145
1 slip joint pliers boxed joints 250 mm	1048N	T153
7 screwdrivers for cross head Phillips® screws \bullet 2,5x50 -3x75 - 3,5x100 - 4x125 -5,5x100 - 5,5x150 - 6,5x150 mm	1260	T199
6 screwdrivers for cross head Phillips® screws \bullet PH0x60 - PH0x100 - PH1x80 - PH1x120 - PH2x100 - PH2x150 mm	1262	T202
2 flat chisels, ribbed type 100-200 mm	35	T234
1 engineer's hammer 300 g	1370	T234
1 soft face hammer \varnothing 35 mm	1390	T234
1 empty thermoformed tray		VP5



Recommended with: RSC23T - RSC24 - RSC24A - RSC24AXL - RSC24AXLP/7 - RSC24L/7 - RSC24L-CAB - C37 - C39 - C39SM - C39MD - RSC28 - C59 - RSC50 - RSC55

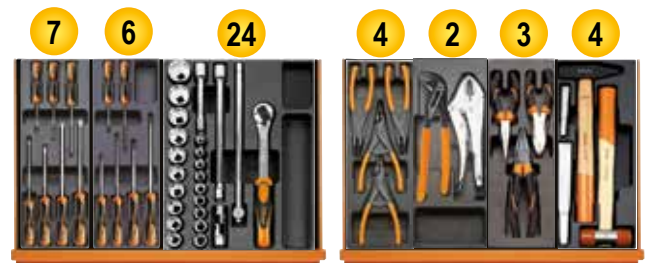

T199 T202 T83 T145 T153 T137 T234



T52 T33 T05 T06 T63 VP5

M01

024500001

£ 527,00 **£ 238,00**



22

4,5 kg

42 6-7-8-9-10-11-12-13-14-15-16-17-18
19-20-21-22-24-27-30-32-36 mm

M30

024500030

£ 478,00 **£ 216,00**



31

4,2 kg

55 6x7-8x9-10x11-12x13-14x15-16x17-18x19-20x22-21x23-24x27-30x32 mm
90 6x7-8x9-10x11-12x13-14x15-16x17-18x19-20x22-21x23-24x27-30x32 mm
96BPC/SC9 1,5-2-2,5-3-4-5-6-8-10 mm

M44

024500044

£ 347,00 **£ 149,00**



12

141 8-9-10-11-12-13-14-15-16
17-18-19 mm

1,3 kg

M60

024500060

£ 464,00 **£ 210,00**



23

1,9 kg

○ 96T 2-2,5-3-4-5-6-7-8-10 mm
○ 97BTX/SC8 T9-T10-T15-T20-T25-T27-T30-T40 mm
○ 944BX 5-6-7-8-10-13 mm

**SOFT
MODULE
SYSTEM**



M63

024500063

£ 419,00 **£ 189,00**



8

3,4 kg

○ 952 7-8-10-12-13-14-17-19 mm

M100

024500100

£ 1.435,00 **£ 615,00**



98

6,7 kg

- 895/1 - 895/3 - 895/6
- 900 4-4,5-5-5,5-6-7-8-9-10-11-12-13-14 mm
- 900ME 3-4-5-6-7 mm
- 900LP 0,8x4-1x5,5-1,2x6,5-1,2x8 mm
- ⊕ 900PH PH1-PH2-PH3-PH4
- 900TX T10-T15-T20-T25-T27-T30-T40
- 900/20 50 mm - 900/20L 100 mm
- 900/21 150 mm
- 900/25
- 900BG/30
- 900/42
- ⊕ 900/55
- 920A 8-10-11-12-13-14-15-16-17-18-19-20-21-22-23-24-26-27-28-30-32 mm
- 920/15 - 920/25
- 920AN/125 125 mm
- 920AN/250 250 mm
- 920/42
- ⊕ 920/55
- ⊕ 920FTX 10-12-14-16-18-20-22-24 mm
- 920AL 10-12-13-14-15-16-17-18-19-21-22 mm

M105 024500871 £1.570,00 **£ 675,00**



116 14" 38" 12"

7,7 kg

- 900 4-4,5-5-5,5-6-7-8-9-10
11-12-13-14 mm
- 900L 5-6-7-8-9-10-11-12-13 mm
- 96BPC/SC9 1,5-2-2,5-3-4-5-6-8-10 mm
- 895/1 - 895/3 - 895/6
- 900ME 3-4-5-6-7 mm
- 900LP 0,8x4-1x5,5-1,2x6,5-2x8 mm
- 900PH PH1-PH2-PH3-PH4
- 900TX T10-T15-T20-T25-T27-T30-T40
- 900/16 □ 1/4 - ■ 3/8
- 900/... 50-100-150 mm
- 900/25 - 900BG/30 - 900/42
- ⊕ 900/55
- 910A 6-7-8-9-10-11-12-13-14-15-16-17-18-19-20-21-22 mm
- 910/15 □ 3/8 - ■ 1/4
- 910/16 □ 3/8 - ■ 1/2
- 910/21 125 mm
- 910/22 250 mm
- 910/25 - 910/42
- ⊕ 910/55
- 920A 8-10-11-12-13-14-15-16-17-18-19-20-21-22-23-24-26-27-28-30-32 mm
- 920/15 □ 1/2 - ■ 3/8
- 920/25 125 - 250 mm
- 920/42
- ⊕ 920/55
- 956E 16-17,8-20,8 mm

M120 024500120 £1.515,00 **£ 650,00**

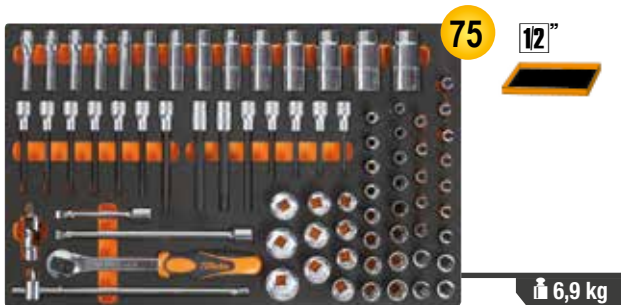

75 12"

6,9 kg

- 920A 10-11-12-13-14-15-16-17-18-19-20-21-22-24-26-27-30-32 mm
- 920AN/125 125 mm
- 920AN/250 250 mm
- 920/25 - 920/42
- 920AL 10-12-13-14-15-16-17-18-19-22-24-27-30-32 mm
- ⊕ 920FTX 10-12-14-16-18-20-22-24 mm
- ⊕ 920/55
- 920PE 5-5L-6-6L-7-7L-8-8L-10-10L-12-12L-14-14L
- 920TX T20-T25-T27-T30-T40-T45-T50-T55-T60-T20L-T25L-T27L-T30L-T40L-T45L-T50L

M129 024500129 £545,00 **£ 234,00**



13

3,4 kg

- 1032 180 mm
- 1034 170 mm
- 1036 175 mm
- 1038 175 mm
- 1048N 250 mm
- 1052 240 mm
- ⊚ 1082BM 160 mm
- 1098 220 mm
- 1112 250 mm
- 1128BM
- ≡ 1150BM 180 mm
- 1166BM 160 mm
- 1168BM 160 mm

M133 024500133 £181,50 **£ 52,00**

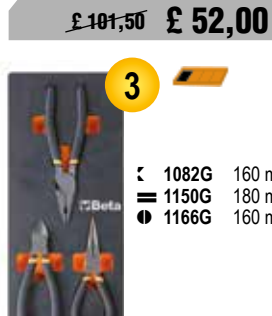

3

650 g

- ⊚ 1082G 160 mm
- ≡ 1150G 180 mm
- 1166G 160 mm

M134 024500134 £133,00 **£ 60,00**



3

750 g

- ⊚ 1082GBM 160 mm
- ≡ 1150GBM 180 mm
- 1166GBM 160 mm

M115 024500115 £1.340,00 **£ 575,00**



54 12"

7,8 kg

- ⊕ 666/20 40+200 Nm
- 920A 13-14-15-16-17-18-19-20-21-22-24-26-27-30-32 mm
- ⊕ 920FTX 12-14-16-18-20-22-24 mm
- 920PE 6-7-8-8L-10-10L-12-12L-14-14L
- 920TX T20-T25-T27-T30-T40-T45-T50-T55-T60-T20L-T25L-T27L-T30L-T40L-T45L-T50L
- 920/21 125 mm
- 920/22 255 mm
- 920/25 305 mm
- 920/42
- ⊕ 920/55

M128 024500128 £1.061,00 **£ 456,00**



50 12"

8,9 kg

- 720 10-11-12-13-14-15-16-17-18-19-21-22-24-27-30-32 mm
- 720L 11-12-13-14-15-16-17-18-19-21-22-24-27-30-32 mm
- ⊕ 720TX T30-T40-T45-T50-T55
- 720ME 5-6-8-10-12-14-17-19 mm
- 720LC 17-19-21 mm
- 720/21 125 mm
- 720/25

M162 024500162 ~~£ 182,00~~ £ 78,00

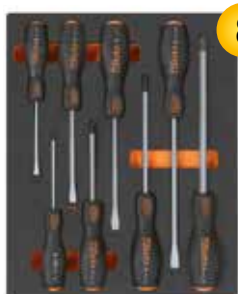

8

- 1241 5,5x100-6,5x125-8x150-10x200 mm
- 1242 PH1x100-PH2x100-PH3x150-PH4x200 mm

1,4 kg

M213 024500213 ~~£ 224,50~~ £ 102,00

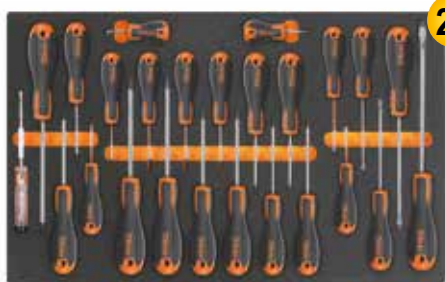

25

1,8 kg

- 1201E 2,5x50-3x75-4x100-5,5x125-6,5x150-8x200 mm
- 1201EN 4x30 mm
- 1202E PH0x60-PH1x80-PH2x100-PH3x150 mm
- 1202EN PH1X30 mm
- 1207E/TX T6-T7-T8-T9-T10-T15-T20-T25-T27-T30-T40-T45
- 1253

M195 024500195 ~~£ 394,00~~ £ 169,00

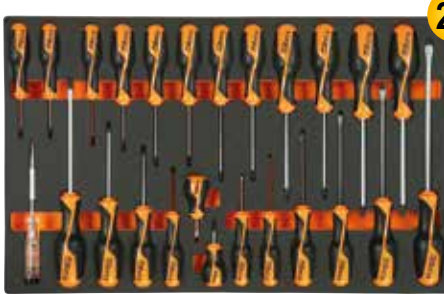

25

- 1260 2,5x50-3x75-4x100-5,5x125-6,5x150-8x200 mm
- 1260N 4x30 mm
- 1262 PH0x60-PH1x80-PH2x100-PH3x150 mm
- 1262 PH1X30 mm
- 1267TX T6-T7-T8-T9-T10-T15-T20-T25-T27-T30-T40-T45 3,5x100 mm
- 1253 3,5x100 mm

2,3 kg

M230 024500230 ~~£ 529,00~~ £ 227,00



25

- 30 Ø 2-3-4 mm
- 31 Ø 2-3-4-5-6-8 mm
- 32 Ø 4 mm
- 34 150 mm
- 35 200-250 mm
- 36 125 mm
- 1370 500 g
- 1390 Ø 35 mm
- 1692 3 m
- 1712
- 1719BMA/Q 200 mm
- ▲ 1719BMA/T 200 mm
- 1719BMA/P 200 mm
- ▶ 1719BMA/M 200 mm
- 1719BMA/R 200 mm
- 1737
- 1771 18 mm

3,2 kg

T01 024240001

~~£ 316,00~~ £ 136,00



17

2,7 kg

- 42 6-7-8-10-11-12-13-14-16-17-18-19-21-22-24-27-30 mm

T05 024240005

~~£ 240,50~~ £ 103,00



16

1,5 kg

- 42 6-7-8-9-10-11-12-13-14-15-16-17-18-19-20-21 mm

T06 024240006

~~£ 170,00~~ £ 73,00



5

2,1 kg

- 42 22-24-27-30-32 mm

T31 024240031

~~£ 283,00~~ £ 122,00



27

3 kg

- 31 Ø 2-3-4-5-6 mm 32 Ø 4 mm
- 55 6x7-8x9-10x11-12x13-14x15-16x17-18x19-20x22-21x23-24x26-27x29-30x32 mm
- 96N/SC9 1,5+10 mm

T40 024240040

~~£ 116,00~~ £ 50,00



7

- 90 6x7-8x9-10x11-12x13-14x15-16x17-18x19 mm

810 g

T45 024240045

~~£ 374,00~~ £ 161,00



12

- 142 8-9-10-11-12-13-14-15-16-17-18-19 mm

1,3 kg

T50 024240050

~~£ 210,00~~ £ 90,00



11

- 96T 2-2,5-3-3,5-4-4,5-5-6-7-8-10 mm

1,3 kg

T55 024240055

~~£ 126,50~~ £ 52,00



6

- 97TTX T10-T15-T20-T25-T27-T30

330 g

T63 024240063
~~£ 408,00~~ **£ 175,00**

8

952 7-8-10-12-13-14-17-19 mm

3,8 kg

T83 024240083
~~£ 387,00~~ **£ 166,00**

24 12"

920A 10-11-12-13-14-15-16-17-18-19-20-21-22-23-24-26-27-30-32 mm
 920/21 125 mm 920/42 305 mm
 920/22 255 mm 920/55 275 mm
 920/25

3,6 kg

T91 024240091
~~£ 259,00~~ **£ 111,00**

25 14"

900 4-4,5-5-5,5-6-7-8-9-10-11-12-13-14 mm
 900ME 2,5-3-4-5-6-8 mm
 900/20 50 mm 900/21 150 mm
 900/25 - 900BG/30 - 900/42 - 900/55

560 g

T92 024240092
~~£ 330,00~~ **£ 142,00**

22 38"

910A 6-7-8-9-10-11-12-13-14-15-16-17-18-19-20-21-22 mm
 910/21 125 mm 910/42 210 mm
 910/22 250 mm 910/55 200 mm
 910/25

1,5 kg

T124 024240124
~~£ 126,50~~ **£ 54,00**

3

1082GBM 160 mm
 1150GBM 180 mm
 1166GBM 160 mm

640 g

T137 024240137
~~£ 141,50~~ **£ 61,00**

3

1084BM 160 mm
 1150BM 180 mm
 1166BM 160 mm

750 g

T145 024240145
~~£ 138,00~~ **£ 59,00**

4

1032 180 mm
 1034 170 mm
 1036 175 mm
 1038 175 mm

640 g

T153 024240153
~~£ 94,50~~ **£ 40,50**

2

1048N 250 mm
 1052 240 mm

1,1 kg

T199 024240199
~~£ 88,50~~ **£ 38,00**

7

1260 2,5x50 - 3x75 - 3,5x100
 4x125 - 5,5x100 - 5,5x150 - 6,5x150 mm

490 g

T202 024240202
~~£ 79,50~~ **£ 34,00**

6

1262 PH0x60 - PH0x100 - PH1x80
 PH1x120 - PH2x100 - PH2x150 mm

490 g

T205 024240205
~~£ 87,50~~ **£ 37,50**

7

1267TX T6-T7-T8-T9-T10-T15-T20

460 g

T211 024240211
~~£ 48,50~~ **£ 21,00**

7

1201E 2,5x50-3x75-3,5x100
 4x125-5,5x100-5,5x150-6,5x150 mm

490 g

T213 024240213
~~£ 54,00~~ **£ 23,00**

6

1202E PH0x60-PH1x80
 PH1x120-PH2x100
 PH2x150-PH3x150 mm

490 g

T234 024240234
~~£ 132,00~~ **£ 57,00**

4

35 100-200 mm
 1370 300 g
 1390 ø 35 mm

1,3 kg

T236 024240236
~~£ 120,50~~ **£ 52,00**

5

1719BMA/Q 200 mm
 1719BMA/T 200 mm
 1719BMA/P 200 mm
 1719BMA/M 200 mm
 1719BMA/R 200 mm

870 g

T239 024240239
~~£ 182,50~~ **£ 78,00**

7

31BM ø 2-3-4-5-6-8 mm
 32 ø 4 mm

850 g

C59A

"Endurance" workbench with 1 cab with 6 drawers

- 6 drawers (588x367 mm) with ball bearing slides
- Worktop made from multiply wood with holes for vice item 1599F/125 - 1599GI/125 (to be ordered separately)
- Drawers protected by foamed rubber mats
- Hard-wearing nylon drawer front
- Roller cabs can accommodate thermoformed trays
- Front centralized safety lock
- Lower object shelf
- Can be fitted with paper roll holder (2400 RSC24/PC) and bottle holder (2400 RSC24/PF-), to be ordered separately



n°	mm	Max kg
4	70 mm	25 kg
1	140 mm	30 kg
1	280 mm	35 kg

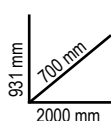

Ral 2011	Ral 7016	Ral 3000
059000011	059000031	059000051
£ 2.065,00		£ 935,00

C56B

Workbench with wood top

- Multi-ply wood worktop with holes for a vice (1599F/125 - 1599GI/125, to be ordered separately)
- Steel frame with 4 supporting legs
- Lower object shelf
- Can be fixed to floor



Ral 2011	Ral 7016	Ral 3000
056000401	056000402	056000403
£ 859,00		£ 430,00

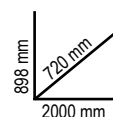

C56PL 0

056000021

~~£ 488,00~~ **£ 221,00**

Folding workbench lightweight reliable

- Lightweight, easy to carry.
- Worktop (800x500mm) made of galvanized sheet iron, for use on one side, protected by an anti-oil and anti-petrol rubber cover.
- Handle with rubber cover, for easy transportation.
- An additional sturdy, reliable worktop, always within reach

**EVEN LIGHTER!
ONLY 18.5 kg**

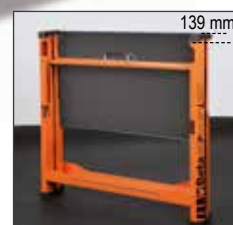
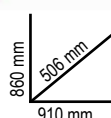

C56

Workbench

- Worktop made of painted sheet metal with external edge
- Steel frame with 6 supporting legs
- Two drawers with lock
- Can be fixed to floor

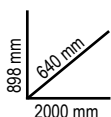

Ral 2011	Ral 7016	Ral 3000
056000201	056000202	056000203
£ 1.220,00		£ 551,00

3068

030680000

NEW!

~~£ 1.092,00~~ **£ 470,00**

Manual pallet truck with low forks

Features:

- 2 steering wheels, 200x50 mm, made of PU
- Double front rollers, 80x70 mm, made of PU
- Pallet access entry and exit rollers
- Depth stop notch
- Lowering speed control valve
- Safety overload valve

Technical data:

- Maximum capacity: 2500 kg
- Overall length: 1200 mm
- Fork length: 800 mm
- Fork width: 540 mm
- Individual fork width: 160 mm
- Lever height: 1230 mm
- Max. lifting height: 115 mm

800 mm

2500
61 kg
3069

030690000

NEW!

~~£ 1.027,00~~ **£ 442,00**

Manual pallet truck

Features:

- 2 steering wheels, 200x50 mm, made of PU
- Double front rollers, 80x70 mm, made of PU
- Pallet access entry and exit rollers
- Depth stop notch
- Lowering speed control valve
- Safety overload valve
- **3-position operating lever**

Technical data:

- Maximum capacity: 2500 kg
- Overall length: 1550 mm
- Fork length: 1150 mm
- Fork width: 540 mm
- Individual fork width: 160 mm
- Lever height: 1230 mm
- Max. lifting height: 115 mm
- Pallet storage corridor: 800x1200 lengthwise: 1805 mm
- Turning radius: 1347 mm

1150 mm

2500
69,5 kg
C99P

099000101

~~£ 219,50~~ **£ 94,00**

Folding tool trolley, made of aluminium

- Ultracompact folding tool trolley, made of anodized aluminium
- Telescopic handle
- Dimensions when open: 485x520x1095 mm
- Dimensions when closed: 485x80x810 mm
- Dimensions of folding base: 485x350 mm
- Two puncture proof wheels, Ø 175 mm
- Supplied with strap

 1095 mm
520 mm
485 mm

 5,8 kg
100
C48P

048000030

~~£ 304,00~~ **£ 156,00**

Folding tool trolley

- Loading platform made of reinforced polypropylene (PP), with non-slip coating and TPV inserts for corner protection
- Retractable handle for quick, compact storage
- Four non-marking castors, Ø 125 mm: 2 fixed and 2 steering with brakes
- Maximum capacity: 300 kg.
- Loading platform working width: 705 mm
- Loading platform depth: 480 mm
- Loading platform height: 200 mm



280 mm

300
11 kg

C48M

048000230

£ 3.920,00 ~~£ 1.690,00~~

Electric platform cart, with panels

- Motorized platform, with 24V - 400W motor with 2x12V 33Ah battery supply and Curtis control card
- Loading floor made from sturdy steel, coated with non-slip rubber, with round tubular panels preventing objects from falling during transport
- The panels can be removed, to cater to individual transportation requirements
- Fitted with 2 pneumatic traction wheels (Ø 260 mm) and 2 swivelling rubber wheels (Ø 150mm), electromagnetic brake and differential gear
- Supplied with an external battery charger, 220V/50Hz - V/A 24/12e

FUNCTIONAL SPECIFICATIONS

- Carrying capacity: **400 kg**
- Driving speed: **4-6 km/h** (adjustable)
- Battery life: **4 hours**
- Maximum permitted slope with a full load: **6%**
- Maximum permitted slope with 100 kg load: **18%**

SAFETY DEVICES:

- Electronic brake
- Buzzer
- Anti-crushing guard
- Battery charge indicator
- Curtis control card

TECHNICAL SPECIFICATIONS

- Overall dimensions: 1280x630x1100 mm
- Useful dimensions of loading platform with panels: 1180x580 mm
- Useful dimensions of loading platform without panels: 1260x620 mm
- Height of loading platform from floor: 320 mm
- Height of battery compartment from floor: 65 mm
- Weight with batteries: 140 kg



Beta
BRUTUS

C51

Trolley

- 3 tops covered in antislip ribbed rubber
- Two fixing options for central worktop
- Four castors Ø 100 mm: 2 fixed and 2 steering (1 with brake)



Ral 2011 Ral 7016 Ral 3000

051000001 051000002 051000003

£ 361,00 ~~£ 163,00~~

C27S

Folding tool trolley for outdoor jobs

- 2 drawers, 588x277 mm, with ball bearing slides, for two-way opening
- Large lower object compartment, 588x277x220 mm
- Sheet metal frame
- 2 fixed castors, Ø 160 mm, and 2 steering castors with brake, Ø 100 mm
- Thermoplastic worktop with 6 built-in tool trays
- Centralized lock
- Can accommodate drawer partitions and MC foam tool trays



- Folding tool trolley. Its unique patented design guarantees an effortless transport



n°	mm	Max
2	70 mm	20 kg



Ral 2011 Ral 7016 Ral 3000

027000201 027000202 027000203

£ 883,00 ~~£ 399,00~~

C41H

Two-module tool trolley

- Sheet metal frame and plastic tops, synonymous with remarkable sturdiness and reduced weight
- 2 detachable modules:
 - 1 upper tool box,
 - 1 module with 2 drawers 95 mm in height, 1 pull-out case made of plastic, 66 mm high, and 1 drawer 295 mm in height
- Oversized castors (160 mm), built into frame for easy transport - for example, on steps
- Side centralized lock for closing drawers of lower module
- Drawers with ball bearing slides and double closing hook
- Telescopic aluminium handle
- Small tool holder built into upper tool box
- Lower drawer with double ballbearing slide



04100002	04100021
04100024	04100006
04100012	04100008
04100010	04100005

~~£ 722,00~~ **£ 332,00**



C20L 021200002 ~~£ 108,00~~ **£ 49,00**

Five-section cantilever tool box, made from sheet metal, empty



≡ 550x200x210 mm

C19 021190001 ~~£ 71,00~~ **£ 30,50**

Three-section cantilever tool box, made from sheet metal, empty



≡ 450x200x160 mm

CP17 021170500 ~~£ 116,50~~ **£ 50,00**

Tool box, made of stainless steel and plastic, removable tote-tray, empty



≡ 500x200x220 mm

C22BL-0 022000170 ~~£ 433,00~~ **£ 186,00**

Tool trunk, made of sheet metal, empty



≡ 1010x410x400 mm

2028/WV 020280010 ~~£ 310,00~~ **£ 133,00**

Tool case, made of polypropylene, empty

- 2 tool panels
- Interior bottom with removable partitions
- Double combination lock

📦 4,9 kg

📏 480x190x400 mm



2032/TV 020320110 ~~£ 553,00~~ **£ 238,00**

Tool trolley, made from plastic, empty

- 2 tool panels
- Tool pocket
- Interior bottom with removable partitions

📏 450x200x400 mm

📦 3,2 kg



2033L/WV 020330250

~~£ 425,00~~ **£ 183,00**

Tool case, made from aluminium, empty

- Highly shock resistant
- Nonscratch finish
- Ergonomic handle with rubber grip
- Double closure with combination
- 2 tool panels with elastic bands
- Interior bottom with removable partitions



📏 470x203x373 mm

📦 6,1 kg

2080/V12 020800000

~~£ 77,00~~ **£ 35,00**

Organizer tool case with 12 removable tote-trays

Removable, folding clear tote-trays, for immediate recognition of contents



📦 1,8 kg

📏 300x330x145 mm



C7AT 021070010 ~~£ 143,00~~ **£ 69,00**

Servicing tool bag made from technical fabric, empty

- Made from super durable technical fabric
- Reinforced base with rubber feet
- Dual top handle for a safe, balanced hold
- Large front document pocket with zip closure and additional compartment with dual strap + clip closure
- dual side pocket with strap closure
- Capacious interior compartment with additional document pocket
- Supplied complete with adjustable padded shoulder strap

- **Front zipper opening on both bag sides** for quick access to tools:
 - 29 compartments and 13 elastic tool bands on front side
 - 33 tool compartments on rear side



📦 2,4 kg

📏 470x200x340 mm



- PC and tablet compartment with protective interior padding (PC size up to L=370 mm, H=250 mm)

NEW!

C9DA 021090005 ~~£ 115,50~~ **£ 53,00**

NEW!

Tool bag with large opening, empty

- Made from super durable technical fabric
- Hard plastic base, water-resistant
- Reinforced top handle for a safe hold
- Dual side pocket with strap closure
- Supplied complete with adjustable padded shoulder strap
- **Two side tool compartments with large openings**, for quick access to and perfect visibility of contents
 - 22 tool pockets and additional compartment with zip closure on front side
 - 14 tool pockets and additional zipped compartment on rear side



1,9 kg
420x220x310 mm

C5 021050000
~~£ 182,50~~ **£ 78,00**

Rucksack, empty

- Removable interior tool panel
- Six exterior pockets and two interior pockets
- Waterproof plastic base
- Double safety lace for fixing rucksack to shoulders
- Ergonomic padded back



2,5 kg
400x200x500 mm

C5S 021050100
~~£ 74,50~~ **£ 34,00**

Tool rucksack, made of hard-wearing polyester, empty

- Double handle on top centre of rucksack for firm, balanced hold
- Two large front pockets
- Two capacious interior pockets
- 2 Velcro tool straps
- Handy roll-up interior bag, composed of 4 tool panels
- Adjustable reinforced shoulder straps
- Maximum carrying capacity: 15 kg



TWO LARGE FRONT POCKETS

900 g
310x120x390 mm

C6T 021060010
~~£ 271,00~~ **£ 123,00**

Rucksack with castors, empty

- Telescopic handle for easy transport
- Built-in castors with practical dustproof cover for use as a rucksack
- Two removable tool panels
- Interior PC pocket and five exterior pockets
- Waterproof plastic base



4,5 kg
360x200x480 mm

Technical fabric tool box, empty

- Hard frame
- Double bottom
- Tilting handle for easier access to tools
- Elastic tool bands and interior and exterior pockets
- Cover
- Tool tray included in double bottom
- Can be used with trolley C8

C10S 021100001 ~~£ 142,50~~ **£ 71,00**

C10 021100000 ~~£ 183,50~~ **£ 91,75**

420x220x250 mm
2,3 kg
520x220x250 mm
3,3 kg



(C10S - 420 mm) (C10 - 520 mm)

C9MT

021090200

~~£ 112,00~~ £ 48,00

NEW!

Maintenance tool bag, empty

- Sturdy PVC cover, waterproof
- Reinforcement seams around the entire perimeter
- Double clip buckle closure
- Double interior handle for a safe, balanced hold
- Zipped document pocket



1,4 kg

450x180x200 mm

2109MT ID/1

021091026

NEW!

~~£ 802,00~~ £ 345,00

Maintenance tool bag C9MT with assortment of 24 plumbing tools



24



Quantity/Description

Quantity/Description	Beta N.
1 Adjustable wrench 250 mm	111E
1 Mini pipe cutter for copper and light alloy pipes Ø 3÷28 mm	332/2
1 Pipe cutter for copper and light alloy pipes Ø 3÷30 mm	334
1 Ratchet-type shears for plastic pipes Ø 0÷42 mm	342
1 Deburrer with fixed blade 140 mm	345SB2
2 Pipe wrenches, Swedish pattern, 90° flat jaws 320-410 mm	376
2 Slip joint pliers, slip-proof PVC coated handles 175-250 mm	1048N
1 Electrician's scissors, straight blades	1128BMX
1 Heavy duty combination pliers, bi-material handles, industrial finish = 180 mm	1150GBM
4 Screwdriver for slotted head screws • 3x75-4x100-5,5x150-8x150 mm	1201E
2 Screwdriver for cross head Phillips® screws • PH1x80-PH2x100	1202E
1 Engineer's hammer 500 g	1370
1 Folding ruler made of fibreglass 2 m	1690F
1 Measuring tape 5 m	1692/5
1 Spirit level, made of aluminium 200 mm	1696
1 Second-cut half-round files 200 mm	1719BMA...M
1 Flat rasp file, plastic handle 200 mm	1719BM/RL
1 Hacksaw frame, aluminium handle	1725

C11

021110000

~~£ 108,00~~ £ 49,00

Technical fabric tool box, empty

- Hard water resistant plastic base
- Elastic tool bands and interior and exterior tool pockets
- Document holders built into double bottom of cover

2 kg

410x230x250 mm



2001/BZ27 VU

020010157

~~£ 341,00~~ £ 154,00

Folding tool case with assortment of 27 tools, for universal use



380x290x60 mm

2005MPU/E

020050065

~~£ 104,00~~ £ 48,00

Tool pouch with assortment of 5 tools



155x285x80 mm



5

Quantity/Description

Quantity/Description	Beta N.
1 electrician's scissors, straight blades	1128BMX
1 combination pliers bright chrome-plated, bi-material handles = 180 mm	1150BM
2 screwdriver for slotted head screws • 3,5x100 - 4x100 mm	1201E
1 screwdriver for cross head Phillips® screws • PH1x80 mm	1202E

Quantity/Description

Quantity/Description	Beta N.
1 electrician's scissors, straight blades	1128BMX
1 combination pliers bright chrome-plated = 180 mm	1150
6 combination wrenches 7-8-10-13-17-19 mm	42
3 screwdriver for slotted head screws • 3x75-4x100-5,5x150 mm	1201E
3 screwdriver for cross head Phillips® screws • PH0x60 - PH1x80 - PH2x100 mm	1202E
9 offset hexagon key wrenches • 1,5-2-2,5-3-4-5-6-8-10 mm	96/SC9
1 engineer's hammer 300 g	1370
1 Slip joint pliers boxed joints 250 mm	1048N
1 measuring tape 5 m	1692/5
1 snap - off blade utility knife 18 mm	1771

A STYLISH, SLIM SHAPE ENHANCED BY A SLENDER PROFILE, LIGHTER TO THE TOUCH.

42

The strength, resilience and ergonomic design of the Beta wrench reach even higher values, to provide users with the best possible tool. The manufacturing process is carried out in our factories in Sovico and Sulmona, on the basis of state-of-the-art automation technology and the best trained workers.

ERGONOMIC

The offset ring has a 15 degree angle to protect the hand. The shape is obtained from a die; it is not bent later.



POWERFUL

Torque values more than doubled compared to the requirements to be satisfied under ISO 1711.

STRENGTH

Remarkable strength: in case of improper use, the wrench buckles, without breaking suddenly and dangerously.



42/SP15

000421078

~~£ 226,00~~ **£ 97,00**

Set of 15 combination wrenches

- with holder

6-7-8-9-10-11-12-13-14-15-16-17-19-22-24 mm



42/SC9I

000421087

~~£ 130,50~~ **£ 56,00**

Set of 9 combination wrenches with compact support

- Compact, practical, easy-to-carry support
- Quickly identified wrench size
- Wrench safely locked in support

8-10-11-12-13-14-15-17-19 mm



42/S26

000421070

~~£ 520,00~~ **£ 224,00**

Set of 26 combination wrenches

6-7-8-9-10-11-12-13-14-15-16-17-18-19-20-21-22-23-24-25-26-27-28-29-30-32 mm



55/B12N

000550164

~~£ 190,50~~ **£ 82,00**

Set of 12 double open end wrenches in roll-up wallet made of durable polyester

6x7-8x9-10x11-12x13-14x15-16x17-18x19-20x22-21x23-24x26-25x28-30x32 mm



142SN/SC9 001420259

~~£ 328,00~~ **£ 145,00**

Set of 9 swivel end ratcheting combination wrenches, with compact support



8-10-11-12-13-14-15-17-19 mm

142/SC9I 001420087

~~£ 268,00~~ **£ 115,00**

Set of 9 reversible ratcheting combination wrenches, with compact support



8-10-11-12-13-14-15-17-19 mm

141/B9 001410069

~~£ 248,50~~ **£ 103,00**

Set of 9 ratcheting combination wrenches, straight series, in cloth wallet

8-10-11-12-13-14-15-17-19 mm

192/S2 001920070

~~£ 79,00~~ **£ 36,00**

Set of 2 reversible ratcheting offset bi-hex ring wrenches

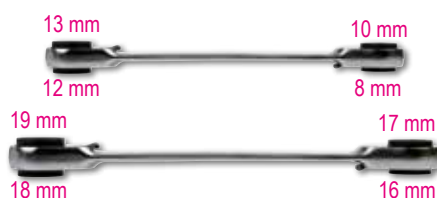
8 SIZES IN 2 WRENCHES

186 8-32 001860008

~~£ 65,00~~ **£ 29,00**

Self-locking wrench with automatic take-up device for hexagons, 8 to 32 mm

Ideal for hexagon, Spline, square and Torx® head screws, including damaged screws



L 260 mm

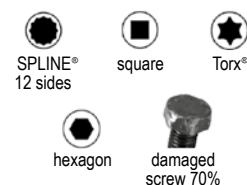

THE ADJUSTABLE WRENCHES WITH SCALES

111E

Head angled at 15°, allowing hardly accessible spaces to be reached, as is the case with our iconic combination wrenches, "42"



Beta 111E allow differently sized nuts and bolts to be tightened and loosened through the sliding jaws, which can be adjusted through the central rolls.

Made from high-performance alloy steel for **increased mechanical torsional strength**

Special heat treatment for excellent **wear resistance**

Double laser marking in mm/inches

Compact head with completely open jaw



Based on the new ergonomic properties, weight has been **reduced by 20%**

Hole on handle for hanging wrench



111E

Adjustable wrenches with scales, **chrome-plated**

- right-hand rotation of pin



111EN

Adjustable wrenches with scales, **phosphated**

- left-hand rotation of pin



	L mm	L "	A max mm		£
111E 100	100	4	15	001110110	£ 25,00 £ 11,50
111E 150	150	6	24	001110115	£ 26,00 £ 12,00
111E 200	200	8	29	001110120	£ 33,50 £ 15,00
111E 250	250	10	34	001110125	£ 42,50 £ 18,50
111E 300	300	12	40	001110130	£ 53,50 £ 24,00
111E 380	380	15	45	001110138	£ 111,00 £ 48,50
111E 450	450	18	54	001110145	£ 187,00 £ 80,00
111E 600	600	24	62	001110160	£ 256,00 £ 116,00

	L mm	L "	A max mm		£
111EN 100	100	4	15	001110410	£ 24,50 £ 11,00
111EN 150	150	6	24	001110415	£ 25,00 £ 11,50
111EN 200	200	8	29	001110420	£ 32,00 £ 14,00
111EN 250	250	10	34	001110425	£ 39,00 £ 17,00
111EN 300	300	12	40	001110430	£ 51,00 £ 23,00
111EN 380	380	15	45	001110438	£ 108,00 £ 46,50
111EN 450	450	18	54	001110445	£ 184,00 £ 79,00

111ER

Reversible jaw adjustable wrenches with scales, **chrome-plated**

- right-hand rotation of pin



111CM

Wide opening adjustable wrenches, **chrome-plated**, short series

- right-hand rotation of pin



	L mm	L "	A max mm	Ø max mm		£
111ER 200	200	6	29	3/4	001110520	£ 41,50 £ 18,00
111ER 250	250	8	34	1	001110525	£ 51,00 £ 22,00
111ER 300	300	10	40	1.1/4	001110530	£ 82,00 £ 33,00

	L mm	L "	A max mm		£
111CM 170	170	6	32	001110770	£ 49,00 £ 21,00
111CM 220	220	8	38	001110722	£ 60,00 £ 26,00
111CM 270	270	10	46	001110727	£ 78,00 £ 35,00

96/SC9

000960374

~~£ 24,20~~ **£ 11,00**

Set of 9 offset hexagon key wrenches

Ø mm	L mm
1,5	45
2	50
2,5	57
3	64
4	72
5	83
6	94
8	105
10	119



COMPACT

96BPC/SC9

000960354

~~£ 46,50~~ **£ 21,00**

Set of 9 ball head offset hexagon key wrenches

Ø mm	L mm
1,5	79
2	84
2,5	89
3	99
4	108
5	126
6	148
8	168
10	187



97BTX/SC8

000970164

~~£ 91,00~~ **£ 40,00**

Set of 8 ball head offset key wrenches, long model, for Torx® head screws

Ø mm	L mm
T9	62
T10	71
T15	81
T20	92
T25	94
T27	105
T30	114
T40	129

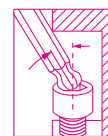

96LBP/SC9

000961354

~~£ 37,00~~ **£ 19,00**

Set of 9 ball head offset hexagon key wrenches

Ø mm	L mm
1,5	90
2	100
2,5	112
3	127
4	144
5	163
6	184
8	204
10	230

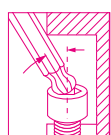

EXTRA LONG VERSION +30%

97BTXL/SC8

000970364

~~£ 83,50~~ **£ 38,00**

Set of 8 ball head offset key wrenches, long model, for Torx® head screws

Ø mm	L mm
T9	80
T10	86
T15	100
T20	110
T25	126
T27	140
T30	160
T40	176

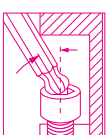

EXTRA LONG VERSION +25%

97BRTXL/SC8

000970464

~~£ 85,00~~ **£ 38,00**

Set of 8 ball head offset key wrenches, long model, for Tamper Resistant Torx® head screws

Ø mm	L mm
T9	80
T10	86
T15	100
T20	110
T25	126
T27	140
T30	160
T40	176

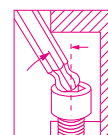

NEW!

EXTRA LONG VERSION +25%

96T/S5P

000960946

~~£ 76,50~~ **£ 33,00**

Set of 5 offset hexagon key wrenches with handles

○ 2,5-3-4-5-6 mm



97TTX/S6

000970791

~~£ 112,00~~ **£ 48,00**

Set of 6 offset key wrenches for Torx® head screws with handles

○ T10-T15-T20-T25-T30-T40



951GP/S6 009511687 ~~£ 182,00~~ **£ 78,00**

NEW!

Set of 6 T-handle wrenches with one hexagon male end

○ 3-4-5-6-8-10 mm

Beta's wrench 951GP is the name for quick, accurate screw fit. Designed to satisfy some key requirements in the Racing world: developing high torque values and ensuring quick tightening.

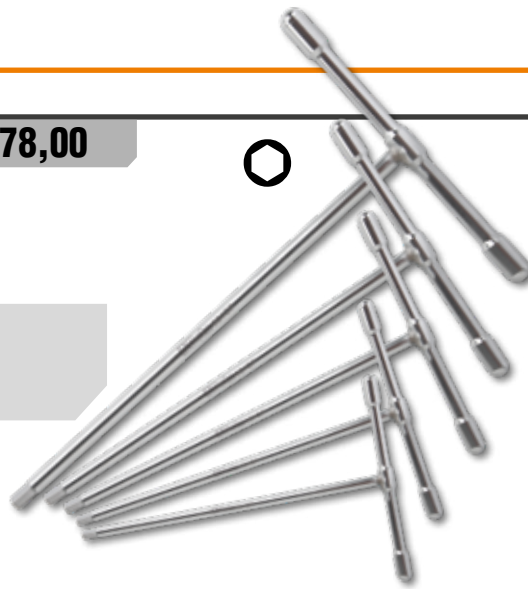

951/S6 009510687 ~~£ 165,50~~ **£ 71,00**

Set of 6 T-handle wrenches with three hexagon male ends

○ 2,5-3-4-5-6-8 mm



952/D7 009520079 ~~£ 304,00~~ **£ 131,00**

Set of 7 T-handle wrenches with swivelling hexagon sockets

○ 7-8-10-12-13-14-17 mm

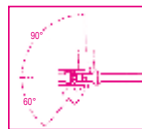

96BP-CL/SC9 000961619 ~~£ 47,00~~ **£ 24,00**

Set of 9 ball head offset key wrenches, coloured

○ mm	L mm
1,5	91
2	102
2,5	113
3	128
4	143
5	163
6	185
8	206
10	231

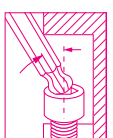

EXTRA LONG VERSION +30%

97BTX-C/SC8 000971658 ~~£ 82,00~~ **£ 35,50**

Set of 8 coloured ball head offset key wrenches, for Torx® head screws

○ mm	L mm
T9	80
T10	86
T15	90
T20	95
T25	100
T27	105
T30	114
T40	124



142MC/SC9I 001422087 ~~£ 281,00~~ **£ 121,00**

Set of 9 reversible ratcheting combination wrenches, coloured, with compact support

○ mm	L mm
8x8	136
10x10	159
11x11	168
12x12	174
13x13	180
14x14	190
15x15	200
17x17	233
19x19	248





COLOR CODE

900MC/C24 009002960

14

~~£ 471,00~~ **£ 203,00**

Assortment of 11 hexagon sockets, 13 coloured socket drivers and 6 accessories, in metal case



1 kg

≡ 270x120x45 mm

	900MC	4-5-6-7-8-9-10-11-12-13-14 mm
	900MC/PH	PH1 - PH2 - PH3
	900MC/TX	T10-T15-T20-T25-T27-T30-T40
	900MC/LP	0,8x4 - 1,2x6,5 - 1,2x8 mm
	900/20	50 mm
	900/21	150 mm
	900/25	
	900BG/30	
	900/42	
	900/55	

920MC/C14 009202964

12

~~£ 379,00~~ **£ 163,00**

Assortment of 14 coloured hexagon hand sockets and 5 accessories, in metal case



4,2 kg

≡ 420x185x60 mm

	920MC	8-10-11-12-13-14-15-16-17-18-19-21-22-24 mm
	920/21	125 mm
	920/22	255 mm
	920/25	
	920/42	
	920/55	

860/C27 008600880

~~£ 109,50~~ **£ 47,00**

Set of 25 bits, 1 connector and 1 reversible ratchet in plastic case



- 860LP 0,5x3-1,0x5,5-1,2x6,5 mm
- 860PE 2-2,5-3-4-5-6 mm
- 860PH PH1-PH2(x2)-PH3
- 860TX T6-T8-T10-T15-T20-T25-T30-T40
- 860PZ PZ1 - PZ2(2x) - PZ3
- 860/55 100 mm
- 892/0

860MIX/A31 008600902

14

~~£ 106,50~~ **£ 46,00**

Set of 30 bits with magnetic bit holder in plastic case



- 860LP 0,5x3 - 0,6x4,5 - 0,8x5,5
1,0x5,5 - 1,2x6,5 mm
- 860PE 2-2,5-3-4-5-6-8-10 mm
- 860PH PH0 - PH1 - PH2 - PH3 - PH4
- 860RTX T9-T10-T15-T20-T25-T27-T30-T40
- 860PZ PZ1 - PZ2 - PZ3 - PZ4
- 882MSR/50 1/4 1/4

1257LPH/S8 012570210

+

~~£ 80,00~~ **£ 36,00**

Set of 8 micro-screwdrivers for slotted head screws and Phillips® screw in hard case



- 1257PH PH00-PH0-PH1
- 1257LP 0,4x2-0,4x2,5-0,5x3
0,6x3,5-0,8x4 mm

≡ 180x120x50 mm

1263MC/D8 012632008

+

~~£ 93,00~~ **£ 40,00**

Set of 8 coloured screwdrivers

- 1260 2,5x50-3x75-4x100- 5,5x125
6,5x150 mm
- 1262 PH0x60-PH1x80
PH2x100 mm



THE FUNCTIONAL, ERGONOMIC BETA EVOX SCREWDRIVER IS ALSO ELECTRICAL NOW!



Life: you can tighten up in up to 1,000 screws with one charging cycle

Flawless grip: it fits your hand and allows a firm, comfortable hold, during both electrical and manual operation, resulting in reduced hand and wrist fatigue.

Convenience: the reduced dimensions and front LEDs make it perfect for use in small, poorly lit spaces.



1/4



BITS INCLUDED:



Versatility: this item caters to all needs; it is supplied with a belt case, complete with 6 50-mm bits with mixed heads. In addition, it can be used with all bits with 1/4" hexagon drives.

1210E/GE

012100701

£ 208,50

£ 86,00

EvoX-E electric screwdriver



Technical data:

- 3.7V 2300mAh lithium battery
- Maximum torque in electric mode: 1.2 Nm
- **Over 1,000 screw fastenings at 1.2 Nm per charging cycle**
- **Speed: 250 rpm**
- **Outstanding static resistance (up to 12 Nm, manual tightening)**
- Outstanding mechanical resistance
- 1/4" magnetic bit holder
- Compatible with all standardized bits
- Rechargeable via USB-C cable (included)
- USB-C port protected with screw cap
- Front ring LEDs for improved visibility of working area
- When charging, steady LEDs indicate that charging is complete
- Ergonomic nylon handle inspired by EvoX screwdriver
- Built-in and sealed operation buttons
- Convenient belt pouch with bit pockets (6 mixed bits included)

1211E/GE

012110701

£ 209,00

£ 95,00

EvoX-E electric screwdriver

1000 V



1203E/D8P 012031018

~~£ 50,00~~ **£ 23,00**
Set of 8 screwdrivers

- 1201E ● 2,5x50-3x75-4x100-5,5x100
6,5x150 mm
1202E ● PH0x60-PH1x80-PH2x100 mm

1203E/D10N 012031019

~~£ 65,50~~ **£ 29,00**
Set of 10 screwdrivers

- 1201E ● 2,5x50-3x75-4x100-5,5x150-6,5x150 mm
1202E ● PH0x60-PH1x80-PH2x100 mm
1201EN ● 4x30 mm
1202EN ● PH1x30 mm

1207E/TX-D7 012071207

~~£ 51,00~~ **£ 26,00**
Set of 7 screwdrivers

- 1207E/TX ● T6-T8-T10-T15
T20-T25-T30

Beta *evox*
**THE EVOLUTION OF
THE SCREWDRIVER!**

1263/D8 012630008

~~£ 89,50~~ **£ 38,50**
Set of 8 screwdrivers

- 1260 ● 2,5x50-3x75-4x100- 5,5x125
6,5x150 mm
1262 ● PH0x60-PH1x80-PH2x100 mm

1263/D10 012630010

~~£ 113,00~~ **£ 48,50**
Set of 10 screwdrivers

- 1260 ● 3x75-3,5x100-4x125-5,5x150-6,5x150 mm
1262 ● PH0x60- PH1x8-PH2x100 mm
1260N ● 4x30 mm
1262N ● PH1x30 mm

1267TX/D7 012670307

~~£ 84,50~~ **£ 36,50**
Set of 7 screwdrivers

- 1267TX ● T6-T8-T10-T15-T20-T25-T30

1293/D6 012930401

~~£ 79,50~~ **£ 34,00**
Set of 6 screwdrivers

- 1290 ● 3,5x75-5,5x150-6,5x150 mm
1292 ● PH0x60-PH1x80-PH2x100 mm

Betamax
MAXIMUM PERFORMANCE

1293INOX/D8 012930408

~~£ 88,00~~ **£ 40,00**
**Set of 8 screwdrivers
made of stainless steel**

- 1290INOX ● 2,5x50-3x75-4x100
5,5x150-6,5x150 mm
1292INOX ● PH0x60-PH1x80-PH2x100 mm

Beta
INOX
STAINLESS STEEL

1243/D7 012430017

~~£ 128,50~~ **£ 55,00**
Set of 7 screwdrivers with steel heads

- 1241 ● 5,5x100-6,5x125
1,2x8x150-1,6x10x200 mm
1242 ● PH1x100-PH2x100
PH3x150 mm



867/C52

008670901

£ 179,50 **£ 77,00**



**52 hexagon bits,
10 mm and 2 accessories**

	867PE	○	4-5-6-7-8-10-12 mm
	867PE/L	○	4-5-6-7-8-10-12 mm
	867XZN	○	M5-M6-M8-M10-M12
	867XZN/L	○	M5-M6-M8-M10-M12
	867TX	⊕	T20-T25-T30-T40-T45-T50-T55
	867TX/L	⊕	T20-T25-T30-T40-T45-T50-T55
	867RTX	⊕	T20-T25-T30-T40-T45-T50-T55
	867RTX/L	⊕	T20-T25-T30-T40-T45-T50-T55
	867/1	○ □	10 mm - 3/8"
	867/2	○ □	10 mm - 1/2"

2,1 kg
250x170x70 mm



52x

862F/A7

008620950

£ 58,00 **£ 26,00**



**Set of 7 magnetic bits,
hexagon sockets,
in plastic case**

862F ○ 5,5-6-7-8-
10-12-13 mm

7x



1600Q 8

016000008

£ 42,00 **£ 19,00**



**Four-way wrench
for control panel operators**

**Wrench for maintenance in
numerous sectors, including
electrical industry, plumbing,
ventilation and gas.**



1600Q 10

016000010

£ 54,00 **£ 24,00**



**Eight-way wrench, with articulated
joint, for control panel operators**

- Eight-way wrench, can be rotated to easily select the head to use
- Magnetic articulated joint for increased force
- 1/4" male drive for use of sockets

**Wrench for maintenance in numerous
sectors, including electrical industry,
plumbing, ventilation and gas.**



1256/C36-2

012560100

£ 91,50 **£ 41,00**

**Bi-material microscrewdriver with 36 interchangeable
4-mm bits and magnetic extension**

	1256TX	⊕	T3-T4-T5-T6-T7-T8-T9-T10-T15
	1256RTX	⊕	T6-T7-T8-T9-T10
	1256LP	●	0,8-1,2-1,5-1,8-2,2-5-3-3,5-4 mm
	1256PE	○	0,7-0,9-1,3-1,5-2 mm
	1256PH	⊕	PH000-PH00-PH0-PH1
	1256PZ	⊕	PZ000-PZ00-PZ0-PZ1
	1256/20		
	1256/30		

130x60x35 mm



38x

200 g

Reversible ratchet

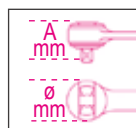

	L mm	Ø mm	A mm	■	teeth		£
900/55	125	25	29	1/4"		009000870	£ 60,00 £ 26,00
910/55	200	30	33	3/8"		009100882	£ 71,00 £ 30,50
920/55	275	40	43	1/2"		009200882	£ 92,00 £ 39,50



**"BETA MINI" TOOL CASE
IS COMPACT AND
EASY TO CARRY**



**FUNCTIONAL, BITS ARE EASY TO
TAKE OUT AND PUT IN**

900/C39N 009000947

1/4" 1/4"

~~£ 248,50~~ **£ 107,00**

**Assortment of 11 hexagon sockets,
21 bits and 7 accessories,
in plastic case**



39x

150x97x53 mm

	900		5-5,5-6-7-8-9-10-11-12-13-14 mm	11
	900/20		50 mm	1
	900/20L		100 mm	1
	900/25			1
	900BG/30C		128 mm	1
	892/0		■ 1/4 - ● 1/4	1
	895/1		○ 1/4 - □ 1/4	1
	861LP		0,6x4,5-1,2x6,5-1,2x8 mm	3
	861PH		PH1-PH2-PH3	3
	861PZ		PZ1-PZ2-PZ3	3
	861PE		2,5-3-4-5-6 mm	5
	861RTX		T10-T15-T20-T25-T27-T30-T40	7
	900/55Z		126 mm	1

900/C39U 009001947

1/4" 1/4"

~~£ 258,00~~ **£ 108,00**

**Assortment of 11 gear lock sockets,
21 bits and 7 accessories,
in plastic case**



39x

150x97x53 mm

MM INCH XZN TX

	900U	mm	5-5,5-6-7-8-9-10-11-12-13-14 mm	11
		"	13/64-7/32-1/4-9/32-5/16-11/32-3/8-7/16-15/32-1/2-9/16	
		XZN	M6-M8-M10-M12-M14-M16-M18	
		TX	E7-E8-E10-E12-E14-E16-E18	
	900/20		50 mm	1
	900/20L		100 mm	1
	900/25			1
	900BG/30C		128 mm	1
	892/0		■ 1/4 - ● 1/4	1
	895/1		○ 1/4 - □ 1/4	1
	861LP		0,6x4,5-1,2x6,5-1,2x8 mm	3
	861PH		PH1-PH2-PH3	3
	861PZ		PZ1-PZ2-PZ3	3
	861PE		2,5-3-4-5-6 mm	5
	861RTX		T10-T15-T20-T25-T27-T30-T40	7
	900/55Z		126 mm	1

900/C11 009000971

~~£ 268,00~~ **£ 112,00**

1/4" 1/4"

**11 hexagon sockets,
20 bits and 8 accessories,
in metal case**



39x

1,2 kg

270x120x45 mm

	861LP		0,5x3-0,8x5,5-1x5,5-1,2x6,5 mm
	861PE		3-4-5-6-8 mm
	861PH		PH0-PH1-PH2-PH3
	861TX		T8-T10-T15-T20-T25-T30-T40
	895/1		○ 1/4" - □ 1/4"
	900		5-5,5-6-7-8-9-10-11-12-13-14 mm
	900/16		□ 1/4 - ■ 1/4"
	900/20		50 mm
	900/21		150 mm
	900/25		
	900/42		
	900BG/30		
	900/55		

902A/C22 009020807 ~~£ 444,00~~ **£ 191,00**

Assortment of 22 hexagon sockets and 6 accessories, in metal case

14"		900	○	5-5,5-6-7-8-9-10-11-12-13 mm
		900/20		50 mm
		900/25		
12"		900/55	⊕	
		920A	○	10-13-14-15-17-18-19-22-24-27-30-32 mm
		920/21		125 mm
		920/25		
		920/55	⊕	



Assortment of 16 hexagon sockets and 5 accessories in foam tray, in metal case

	910A	○	6-7-8-9-10-11-12-13-14-15-16-17-18-19-21-22 mm
	910/21		125 mm
	910/22		250 mm
	910/25		
	910/42		210 mm



910A/C16 009100936 ~~£ 347,00~~ **£ 149,00**

Reversible ratchet (910/55)



910A/C16HR 009100935 ~~£ 389,00~~ **£ 167,00**

Reversible ratchet with rotating handle (910/58)



Assortment of 17 hexagon sockets and 5 accessories in foam tray, in metal case

	920A	○	10-11-12-13-14-15-16-17-18-19-20-21-22-24-27-30-32 mm
	920/21		125 mm
	920/22		255 mm
	920/25		
	920/42		305 mm



920A/C17M 009200924 ~~£ 404,00~~ **£ 174,00**

Reversible ratchet (920/55)



920A/C17MR 009200937 ~~£ 437,00~~ **£ 188,00**

Reversible ratchet with rotating handle (920/58)



928A/C12 009280955 ~~£ 970,00~~ **£ 417,00**

Assortment of 12 hexagon hand sockets and 5 accessories, in metal case

	928A	○	22-24-27-30-32-34-36-38-41-46-50-55 mm
	928/21		200 mm
	928/22		380 mm
	928/25		
	928/42		450 mm
	928/55	⊕	



THE TORQUE WRENCH THAT DOES NOT REQUIRE RELEASING TENSION

NEW!

Even if tension is not released, the number of cycles, durability and tightening accuracy as required by reference standards are guaranteed.

In order to confirm these parameters, Beta Utensili's Research & Development Department performed numerous durability tests at the in-house laboratories as at hundreds of end users.

This result has been obtained through:

- the use of the best-performing currently available materials;
- special heat treatments on interior parts.

ZERO-RESET

100% MADE IN ITALY

The Zero-Reset torque wrench was entirely designed and developed in-house and is manufactured at Beta Utensili's factories in Italy, using 100% Italian-made parts.

ZERO-RESET TECHNOLOGY: Based on higher-performance materials and improved heat treatment of both the spring and the component parts of the adjustment system, the wrench no longer requires releasing tension after use.

EASY SETTINGS: The graduated scale allows minimum interval fractions to be set up (in tenths of Nm/lbf.ft).

IMPROVED VISIBILITY: Double graduation for clearer, simpler torque visibility.

666

ZERO-RESET click-type torque wrenches with reversible ratchets, for right-hand tightening, torque accuracy: $\pm 3\%$

1/4" 3/8" 1/2"

UNI EN ISO 6789



	Nm	lbf.ft	■	▤▤▤▤	L (mm)	g	📦	£	£
666/2	5÷25		1/4"	0,05	273	395	006660702	£ 286,00	£ 129,00
666/2X	5÷25		3/8"	0,05	273	405	006660703	£ 286,00	£ 129,00
666/5	10÷50		3/8"	0,25	342	680	006660705	£ 256,00	£ 116,00
666/10	20÷100		3/8"	0,25	385	760	006660710	£ 258,00	£ 117,00
666/10X	20÷100		1/2"	0,25	385	770	006660711	£ 260,00	£ 118,00
666/20	40÷200		1/2"	0,5	471	1020	006660720	£ 286,00	£ 129,00
666/30	60÷300		1/2"	1	600	1271	006660730	£ 331,00	£ 149,00
666-LBF.FT/2		4÷18	1/4"	0,05	273	395	006660762	£ 286,00	£ 123,00
666-LBF.FT/2X		4÷18	3/8"	0,05	273	405	006660763	£ 286,00	£ 123,00
666-LBF.FT/5		7÷37	3/8"	0,25	342	680	006660765	£ 256,00	£ 110,00
666-LBF.FT/10		15÷75	3/8"	0,25	385	760	006660780	£ 258,00	£ 111,00
666-LBF.FT/10X		15÷75	1/2"	0,25	385	770	006660781	£ 260,00	£ 112,00
666-LBF.FT/20		30÷150	1/2"	0,5	471	1020	006660782	£ 286,00	£ 123,00
666-LBF.FT/30		50÷230	1/2"	1	600	1271	006660783	£ 331,00	£ 142,00



667

ZERO-RESET click-type torque wrenches with push-through ratchets, for right-/left-hand tightening, torque accuracy: $\pm 3\%$

1/2" 3/4"

UNI EN ISO 6789



	Nm	■	▤▤▤▤	L (mm)	g	📦	£	£
667/20	40÷200	1/2"	0,5	471	1035	006670720	£ 351,00	£ 151,00
667/30	60÷300	1/2"	1,0	600	1285	006670730	£ 393,00	£ 169,00
667/40	80÷400	3/4"	1,0	710	2220	006670740	£ 964,00	£ 415,00

605DGT/2 006050302 ~~£ 297,00~~ £ 152,00

NEW!

Electronic torque wrench with reversible ratchet for right-/left-hand tightening torque accuracy ± 3% (right-hand) ± 4% (left-hand)

- Dual measurement mode: peak hold and track
- Light indicators and an intermittent sound inform user that preset torque has been reached
- Power supply: 1 1.5V AAA battery (included)



Nm	kgcm	lbf.ft	■	L (mm)	
4÷20	10÷204	0,75÷14,75	1/4"	210	0,01



605E 1/4"

UNI EN 26789 ISO 6789

Click-type torque wrenches with reversible ratchets for right-hand and left-hand tightening torque accuracy: ± 6%



	Nm	kgfm	lbf.ft	■	L (mm)		g	■	£
605E/5	1÷5	0,1÷0,5	10÷45	1/4"	190	0,05	180	006050105	£ 270,00 £ 122,00
605E/10	2÷10	0,2÷1,0	18÷90	1/4"	190	0,1	180	006050110	£ 286,00 £ 129,00

610L 1/2"

UNI EN ISO 6789

Click-type torque wrenches with L-shaped levers, for right-hand tightening, with 5 preset values, torque accuracy: ± 4%



L mm	L1 mm
470	80

610L/5 006100125
~~£ 212,00~~ **£ 91,00**

Selectable torque values:
90 - 100 - 110 - 120 - 130 Nm

610L/5L 006100150
~~£ 236,50~~ **£ 107,00**

Selectable torque values:
120 - 140 - 160 - 180 - 200 Nm



677/C 3/4"

677/C800 UNI EN 26789 ISO 6789

Break-back torque wrenches with push-through ratchets, for right-hand and left-hand tightening, torque accuracy: ±4% in case

The break-back torque wrench, Beta 677, is particularly suitable for heavy-duty use at high torques. The break-back mechanism informs the user that the set torque has been reached through the bending of the wrench at the joint by approximately 20°.

- Wrench composed of two parts: lever with ratchet and break-back system with torque adjustment



	Nm	kgfm	lbf.ft	■	L (mm)		kg	■	£
677/C600	120÷600	12÷60	100÷450	3/4"	1059	10	6,0	006770607	£ 1.265,00 £ 595,00
677/C800	200÷800	20÷80	150÷600	3/4"	1319	10	6,7	006770612	£ 1.315,00 £ 651,00
677/C1000	300÷1000	30÷100	200÷750	3/4"	1554	20	7,4	006770616	£ 1.395,00 £ 688,00

THE DECENTRALIZED PIN ALLOWS THE FULCRUM TO BE CLOSER TO THE CUTTING POINT, THEREBY RESULTING IN AN IMPROVED LEVER EFFECT

1169BM/D3 011690133

£124,50 **£ 54,00**

Set of 1 combination pliers, 1 long needle nose pliers and 1 diagonal cutting nippers



1169GBM/D3 011690273

£113,50 **£ 49,00**

Set of 1 combination pliers, 1 long needle nose pliers and 1 diagonal cutting nippers, bi-material handles, industrial finishing



1169N/D4 011690024

£137,50 **£ 62,00**

Set of 1 heavy-duty combination pliers, 1 long needle nose pliers, 1 cutting nippers, chrome-plated, and 1 slip joint pliers with boxed joints, phosphated



1031/S4 010310000

£124,00 **£ 56,00**

Set of 4 circlip pliers

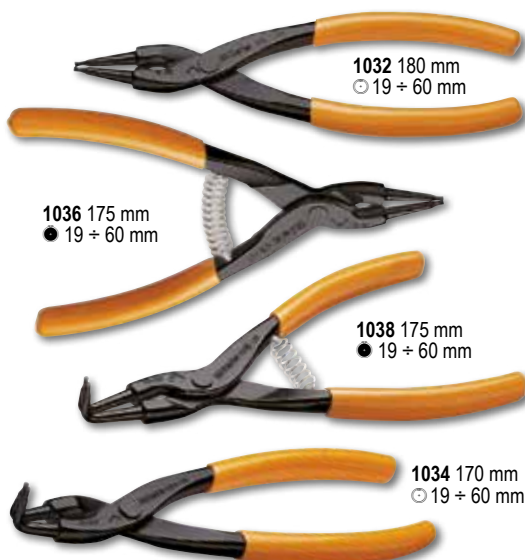

1150HPC 011500618

£92,50 **£ 41,25**

Heavy duty combination pliers with cutting edges made of sintered steel

- The decentralized pin allows the fulcrum to be closer to the cutting point, thereby resulting in an improved lever effect.
- Perfect alignment of the nose and the thin profile allow the pliers to be used in very small areas.
- The body of the pliers is made of a reliable molybdenum steel which has been heat treated in order to be flexible and resistant so as to guarantee a safe grip in any moment.

**ABSOLUTELY GROUNDBREAKING
REMARKABLE CUTTING
CAPACITY**

Shearing stress - static test = **-73%**

Average life of cutting edges = (test ISO 5744) **+127%**

Hardness of M2 steel cutting edges = **65HRC**



PATENTED

SLIP JOINT PLIERS, BOXED JOINTS, OUTSTANDING GRIP AND AMAZING HANDLING

1048N



Induction hardened teeth for longer durability



New tooth geometry for effective, **safe grip** on hexagonal and cylindrical profiles

Contrast retainer preventing accidental hand crushing



Wider head/handle angle for improved ergonomic handling

Extraordinary handling and comfort thanks to the large contact surface of the handle

Other features:

- Triangular section grip for a more comfortable contact surface
- Tapered head allowing access to small spaces
- Case-hardened nail for improved wear resistance
- The handles coated with innovative slip-proof PVC ensure a secure grip.
- Phosphated finish
- Made from chrome-vanadium steel

Up to 60 mm for the 300 mm size

UP TO EIGHT ADJUSTMENT OPTIONS



DIN ISO 8976

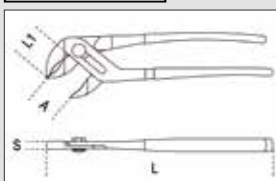

1048N

Slip joint pliers, slip-proof PVC coated handles

	L mm	A Max mm	L1 mm	S mm	g		£	£
1048N 175	175	36	31	11	189	010480910	£ 40,00	£ 17,00
1048N 250	250	46	38	13	354	010480915	£ 43,00	£ 19,00
1048N 300	300	60	44	14,8	554	010480920	£ 60,00	£ 27,00
1048N 400	400	96	81	19	1180	010480940	£ 105,50	£ 48,00

NEW!

1048N/D3 010480923

~~£ 143,00~~ **£ 61,00**

Set of 3 slip joint pliers



1048VN

Slip joint pliers, boxed joints, with orange lacquered finish



	L mm	A Max mm	L1 mm	S mm	g		£	£
1048VN 175	175	36	31	11	189	010480111	£ 32,00	£ 14,00
1048VN 250	250	46	38	13	354	010480116	£ 34,50	£ 15,00
1048VN 300	300	60	44	14,8	554	010480121	£ 55,00	£ 23,50

1199ESD/D3 011990003 ~~£ 134,50~~ **£ 58,00**

NEW!

Set of 1 flat long nose pliers,
1 diagonal axial cutting nippers
and 1 semi-flush cutting nippers, ESD



1172ESD
135 mm



1188ESD
115 mm



1190ESD
115 mm

1052

Adjustable self-locking pliers,
concave jaws



	L mm	ø Max mm	g		£	£
1052/140	140	22	175	010520014	£ 28,00	£ 12,00
1052/190	190	36	360	010520019	£ 32,00	£ 14,00
1052/240	240	42	590	010520024	£ 40,50	£ 17,50
1052/300	300	55	900	010520030	£ 58,00	£ 25,00

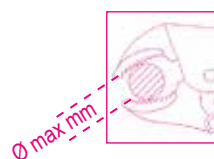

1009L/DP-S2 010090060 ~~£ 85,00~~ **£ 38,00**

Set of 2 extra-long, knurled
double swivel nose pliers



437U/09 004370550

~~£ 477,00~~ **£ 215,00**

Assortment for repairing
damaged threads
in metal case

- M5X0,8
- M6X1,0
- M8X1,25
- M10X1,5
- M12X1,75



370x230x55 mm

437P 004370003

~~£ 62,50~~ **£ 28,00**

Thread dresser, for repairing internal
and external, right-hand and left-hand
threads

- P 0,80-1,00-1,25-1,50-1,75-
- 2,00-2,50-3,00 mm



419/SP7 004190507

~~£ 85,00~~ **£ 36,50**

Set of 7 hammer drill bits with SDS-plus seat

- 2 cutters
- 4 spirals
- For drilling into walls, cement, concrete, stones

HVA~ 1650

NEW!



115x170x40 mm



412M/SP19 004120469

~~£ 108,50~~ **£ 46,50**

Set of 19 twist drills with cylindrical shanks, HSS, AISI M2, entirely grounded finishing

- Self-centring
- High performance and cutting accuracy
- For drilling alloy steel, cast iron and metal in general

Ø 1÷10 x 0,5 mm

R ≤ 850 N/mm²
HV ≈ 820
DIN 338



115x170x40 mm



415CO/SP19A 004150440

~~£ 181,50~~ **£ 78,00**

Set of 19 twist drills with cylindrical shanks, HSS-CO 5%

- For drilling holes into STAINLESS steel, alloy steel, cast iron, mild steel, light alloys

Ø 1÷10 x 0,5 mm

R ≤ 1200 N/mm²
HV ≈ 800÷860
DIN 338



115x170x40 mm



416P/SP19 004160469

~~£ 177,00~~ **£ 76,00**

Set of 19 twist drills with cylindrical shanks, made from HSS, AISI M2, with smaller drill for high-precision centring

Ø 1÷10 x 0,5 mm

R ≤ 900 N/mm²
HV ~ 820÷850

HIGHER DRILLING SPEED



115x170x40 mm



451/C8 004510308

~~£ 382,00~~ **£ 172,00**

Assortment of 8 hole cutters, HSS, entirely grounded

- Maximum thickness: 4 mm



270x225x70 mm

NEW!

446/C110 004460060

~~£ 1.230,00~~ **£ 530,00**

Assortment of 105 chrome-steel taps and dies, metric thread, and 5 accessories for car repair jobs in wooden case

I III	III	23	23
430 M mm	433 M mm	440/440A M mm	441/441A M mm
2x0,4	6x0,75 - 7x0,75	2x0,4	6x0,75 - 7x0,75
3x0,5	8x0,75 - 8x1	3x0,5	8x0,75 - 8x1
4x0,7	9x0,75 - 9x1	4x0,7	9x0,75 - 9x1
5x0,8	10x0,75 - 10x1	5x0,8	10x0,75 - 10x1
6x1	10x1,25 - 11x0,75	6x1	10x1,25 - 11x0,75
7x1	11x1 - 11x1,25	7x1	11x1 - 11x1,25
8x1,25	12x0,75 - 12x1	8x1,25	12x0,75 - 12x1
9x1,25	12x1,25 - 12x1,5	9x1,25	12x1,25 - 12x1,5
10x1,5	14x1 - 14x1,25	10x1,5	14x1 - 14x1,25
11x1,5	14x1,5 - 16x1	11x1,5	14x1,5 - 16x1
12x1,75	16x1,5 - 18x1,5	12x1,75	16x1,5 - 18x1,5
14x2		14x2	
16x2		16x2	

435/0 444/1 436/1
435/3 444/2



500x337x60 mm

1545/C5M 015450011 ~~£ 670,00~~ £ 288,00

Puller 1542/1
with 5 extractors 1544

	A mm	C mm
1544/1	9÷12	0,80
1544/2	13÷17	1,15
1544/3	16÷21	1,70
1544/4	20÷25	1,65
1544/5	25÷30	2,00

265x180x45 mm

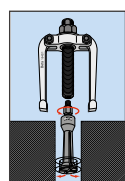

1430/S5 014300105

~~£ 32,50~~ £ 15,00

Set of 5 tapered extractors
for broken screws and studs,
made from hardened steel in case

1430/1-1430/2-1430/3
1430/4-1430/5



1500

Two-leg universal pullers

- For both external and internal use
- Legs can be moved along crosspiece with stop nuts

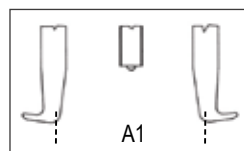

	A min÷Max mm	L mm	L1 mm	● mm	A1 min÷Max mm		£
1500/1	25÷80	100	135	17	70÷130	015000301	£ 102,00 £ 47,00
1500/2	25÷130	100	135	17	80÷180	015000302	£ 104,00 £ 48,00
1500/3	50÷160	150	210	22	105÷220	015000303	£ 181,00 £ 83,00
1500/4	60÷200	150	210	22	120÷270	015000304	£ 253,00 £ 116,00
1500/5	80÷250	205	280	27	160÷330	015000305	£ 465,00 £ 214,00
1500/6	80÷320	205	280	27	160÷420	015000306	£ 539,00 £ 248,00
1500/7	110÷520	205	280	27	195÷600	015000307	£ 807,00 £ 371,00
1500/8	170÷640	230	310	36	260÷715	015000308	£ 1.295,00 £ 595,00



BETA'S PULLER 1517C

Relies on a leg self-locking mechanism triggered by the spring on the crosspiece. This feature makes it easy to position and lock the puller on the part to remove. After the puller has been fixed in place, the legs can be locked by means of the ring nut. The peculiar crosspiece has 4 seats which allow the 1517C puller to be used with both 2 legs – for easier, quicker jobs – and 3 legs – for increased firmness. The shear pin on the screw head breaks when the maximum permissible torque is exceeded, thereby protecting the puller from overloads.

1517C

Combination two/three-leg self-locking pullers

- Leg holder with configuration for 2- or 3-leg use
- Simultaneous leg opening
- Self-locking effect
- With shear pin
- Size 2 with screw extension (total length of screw with extension: 380 mm)

	A min÷Max mm	L mm	L1 mm	● mm		£
1517C/0	12÷140	145	250	18	015170500	£ 300,00 £ 135,00
1517C/1	20÷180	200	300	18	015170501	£ 370,00 £ 167,00
1517C/2	30÷280	270	300	18	015170502	£ 458,00 £ 207,00



33NR NEW!

Number punches

- For engraving steel with resistance R up to 80 kg/mm²
- Kit of 9 punches: numbers 0 to 9



	H mm	L mm	A mm	Art. No.	£	£
33NR 3	3	61	6,35	000330003	£ 25,50	£ 11,00
33NR 4	4	62	7,93	000330004	£ 30,50	£ 13,00
33NR 5	5	62	7,93	000330005	£ 30,50	£ 13,00
33NR 6	6	68	9,52	000330006	£ 37,00	£ 16,00
33NR 8	8	71	12,7	000330008	£ 54,00	£ 23,00

33LT NEW!

Letter punches

- For engraving steel with resistance R up to 80 kg/mm²
- Kit of 27 punches: letters A to Z + &



	H mm	L mm	A mm	Art. No.	£	£
33LT 3	3	61	6,35	000330023	£ 70,50	£ 30,50
33LT 4	4	62	7,93	000330024	£ 86,00	£ 37,00
33LT 5	5	62	7,93	000330025	£ 86,00	£ 37,00
33LT 6	6	68	9,52	000330026	£ 106,00	£ 45,50
33LT 8	8	71	12,7	000330028	£ 158,50	£ 68,00

1370

Mechanic's hammers wooden shaft

UNI 7778 DIN 1041



	g	g	Art. No.	£	£
1370/300	300	439	013700053	£ 22,10	£ 9,50
1370/500	500	669	013700055	£ 25,00	£ 11,00
1370/800	800	949	013700058	£ 28,50	£ 12,50
1370/1000	1000	1180	013700060	£ 36,00	£ 15,50
1370/1500	1500	1722	013700065	£ 38,50	£ 16,50
1370/2000	2000	2181	013700070	£ 43,00	£ 18,50

31BM/D6 000310420

~~£ 155,50~~ **£ 67,00**

Set of 6 pin punches with handles

Ø 2-3-4-5-6-8 mm



32AU 000320160

~~£ 79,00~~ **£ 33,00**

Automatic centre punches



1370T

Mechanic's hammers fibre shaft



	g	g	Art. No.	£	£
1370T/300	300	452	013700630	£ 31,00	£ 13,50
1370T/500	500	663	013700650	£ 37,00	£ 16,00
1370T/800	800	1017	013700680	£ 38,00	£ 16,50
1370T/1000	1000	1279	013700700	£ 44,00	£ 19,00
1370T/1500	1500	1740	013700750	£ 52,50	£ 22,50

1390

Soft face hammers, wooden shaft

UNI 7784



	Ø mm	g	Art. No.	£	£
1390/22	22	134	013900022	£ 25,00	£ 12,00
1390/28	28	230	013900028	£ 31,50	£ 13,50
1390/35	35	365	013900035	£ 43,00	£ 18,50
1390/45	45	689	013900045	£ 69,00	£ 29,50
1390/60	60	1462	013900060	£ 115,50	£ 49,50

1719BMR/B3

017190358

~~£ 58,50~~ £ 25,00

NEW!

Set of 3 second-cut rasps, with handles, in hanging wallet



1650

Sliding gauge made from hardened stainless steel

- Reading to 0.05 mm
- Spring locking

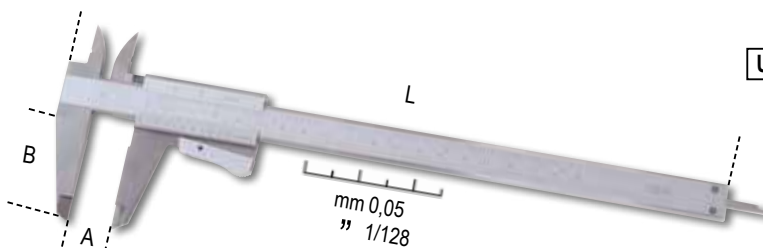

DIN 862

UNI EN ISO 13385-1



	A Max mm	L mm	B mm	G mm		£
1650/150	150	150	40	0,05-1/128	016500001	£ 87,00 £ 37,50
1650/200	200	290	49	0,05-1/128	016500002	£ 125,50 £ 54,00

1651DGTB

Digital vernier, reading to 0.01 mm

- Screw slider locking
- Mm/inch conversion
- Zero setting at any position
- Square depth rod up to 300 mm
- In hard plastic case



DIN 862

UNI EN ISO 13385-1



	A Max mm	L mm	B mm	G mm		£
1651DGTB 150	150	235	40	0,01-0,0005	016510211	£ 120,00 £ 55,00
1651DGTB 200	200	285	50	0,01-0,0005	016510212	£ 211,00 £ 91,00
1651DGTB 300	300	400	60	0,01-0,0005	016510213	£ 242,50 £ 109,00

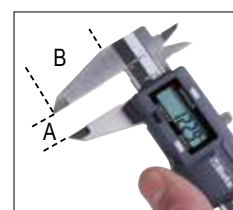

1674C

016740230

~~£ 22,20~~ £ 11,00

NEW!

Carpenter's combination square with steel blade

- Double mm scale
- Surface level

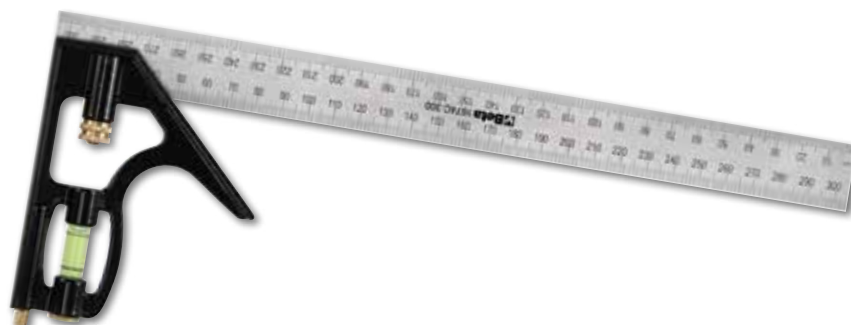

1691MG

Measuring tapes with fixed magnets

- Shock-resistant ABS casings
- Steel tapes
- Precision class: II

	L m	S mm		£	£
1691MG/5	5	25	016910405	£ 14,40	£ 7,00
1691MG/8	8	25	016910408	£ 23,60	£ 11,00
1691MG/10	10	25	016910410	£ 28,50	£ 13,00



MAGNETIC



1693L 40

016930040

IP54

~~£ 225,00~~ **£ 102,00**



Laser distance meter, multipurpose, 40 m, with positioning levels

MEASUREMENTS:

- Single distance measurement
- Continuous measurement or minimal measurement

FUNCTIONS:

- Addition/subtraction
- Area measurement
- Volume measurement
- Variable indirect measurement (Pythagorean measurement)
- Tilt measurement
- Auto power off
- Battery life: up to 5,000
- Soft cloth case (included) measurements

TECHNICAL DATA:

- Measurement range: 0.05 ÷ 40 m (0.2in ÷ 131ft)
- Scale selection: m, in, ft
- Measurement accuracy: ±1.5 mm (± 0.06 in)
- Laser class: 2
- Max. storage: 99 units
- Batteries: AAA 2 x 1.5V

40 m



POSITIONING LEVELS

1693M 80

016930080

IP54

~~£ 287,00~~ **£ 123,00**



Laser distance meter, multipurpose, 80 m

MEASUREMENTS:

- Single distance measurement
- Continuous measurement or minimal measurement

FUNCTIONS:

- Addition/subtraction
- Area measurement
- Volume measurement
- Indirect measurement (Pythagorean measurement)
- Tilt measurement
- Auto off feature
- Soft cloth case (included)
- Battery life: up to 4,000 measurements

TECHNICAL DATA

- Measurement range: 0.05 ÷ 80 m (0.2 in ÷ 229ft)
- Scale selection: m, in, ft
- Measurement accuracy: ±1,5 mm (± 0.06 in)
- Laser class: 2
- Max. storage: 99 units
- Battery: AAA 2 x 1.5V

80 m

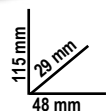

1696B

Spirit levels with magnetic bases made from anodized profiled aluminium, 2 unbreakable vials

- Precision 1 mm/m

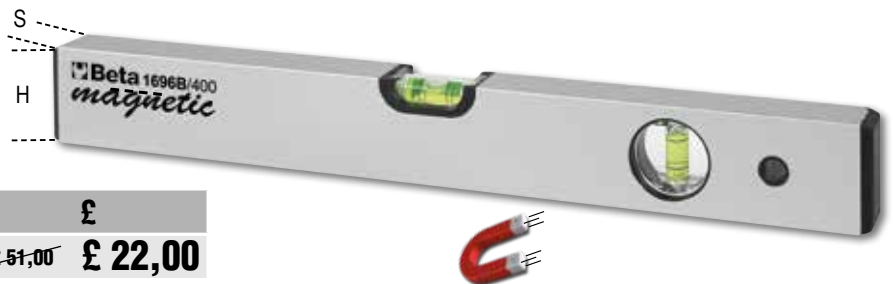

	L mm	H mm	S mm		£	£
1696B 200	200	49	22	016960202	£ 51,00	£ 22,00
1696B 300	300	49	22	016960203	£ 52,50	£ 22,50
1696B 400	400	49	22	016960204	£ 54,00	£ 24,00
1696B 500	500	49	22	016960205	£ 62,00	£ 28,00
1696B 600	600	49	22	016960206	£ 65,00	£ 28,00

1697 30

016970030

~~£ 361,00~~ **£ 163,00**
Cross laser level, 30 metres, green beam, with magnetic base and wall-mount bracket, in case

- Self-levelling cross
- Self-levelling function can be switched off for manual use
- Laser diode 515 Nm, class 2
- Working range: 30 m
- Accuracy: ± 1 mm at 5 m
- Self-levelling range: $3^\circ \pm 0.5^\circ$
- Body made of ABS and nonslip rubber
- 1/4" female drive
- 2xAA batteries
- Battery life: 4 hours

30 m

IP55

- BASE:
- 1 magnetic base for individual and combined use, 1/4" male drive
 - 1 adjustable tightening bracket for several wood and metal profiles (for use in combination with magnetic base)
 - quick horizontal and vertical alignment at a 90° angle



320x230x90 mm

1760/RMS

017600020

~~£ 394,00~~ **£ 177,00**
IP67

Industrial digital multimeter accurate and sturdy, in a 6-mm co-moulded shell, with antislip, shockproof outer rubber part

- Water protection IP67
- Protection up to 1000V
- Tested for accidental falls up to 2 m
- Protected inlets
- Autoranging
- Large direct reading display, backlit, blue
- K type temperature probe (included)
- Self-power down
- Rubber terminal base for enhanced operating comfort
- Double insulated terminals, 1000V, 1 m long
- Supplied in a soft case
- CAT IV 600V/ CAT III 1000V
- Actual effective value TRUE RMS

1760S

017600022

~~£ 121,00~~ **£ 55,00**
IP40

Compact digital multimeter

- IP40 protection
- Autoranging
- Large direct reading display, backlit, blue
- Self-power down
- Low battery indication
- Supplied in a soft case
- CAT III 600V
- TRUE RMS (actual effective value)

Measurable parameters:

DC voltage: 200 mV - 2/20/200/600V
 AC voltage: 100/600V
 DC current: 200 mA - 10 A
 AC current: 0,01 - 10 A
 Resistance: 200Ω - 2/20/200 kΩ - 2 MΩ
 Diode test: 0.4 ÷ 0.7
 Power supply: 2 1.5V batteries, type AAA

	Measuring range	Base accuracy
AC/DC voltage	110mV – 600V $\pm 0.8\%$	- $\pm 2\%$ rdg
AC/DC current	110μA – 10A $\pm 1.5\%$	- $\pm 2\%$ rdg
Resistance	110Ω – 40MΩ $\pm 1.2\%$	- $\pm 2.5\%$ rdg
Capacity	11nF – 40mF $\pm 5\%$	- $\pm 10\%$ rdg (up to 11mF)
Frequency	1100Hz – 110 MHz $\pm 1.2\%$	- $\pm 1.5\%$ rdg
Temperature	-32°C – +1000°C $\pm 3\%$	- $\pm 5\%$ rdg
Diode test	3V DC $\pm 10\%$ rdg	
Continuity test	<30 Ω	

1760TMC

017600710

~~£ 1.250,00~~ **£ 540,00**
Infrared thermal camera

- LCD TFT display, 2", 240x320
- Sensor, 32x32 pixels
- Acquisition frequency 7Hz
- Thermal sensitivity <347mK
- Automatic acquisition of hot and cold spots camera for acquisition of images in BMP format (max. 100 images) adjustable emissivity
- Power supply: 3 alkaline AAA batteries
- USB interface
- Temperature range: -20 °C ÷ +600 °C
- Infrared band: 6.5÷14μm
- visible/infrared image fusion: 0.5; 1; 2m
- Alarm function, selecting acceptable maximum and minimum temperatures

Compact thermal camera for contactless temperature measurement, suitable for applications in building, mechanical, electric installation and heating industries

TEMPERATURE RANGE
-20 ÷ +600°C

IP54

Since 2022 the established, authoritative welding specialist, Helvi, and Beta Utensili have been working together to develop ground-breaking technologies. This joint effort has translated into the new range of Beta by Helvi welding machines, which boast ultimate performance in line with its high quality standards.

Easy-to-use inverter welding machines with excellent welding characteristics for all types of electrodes. With overvoltage and overtemperature control and electrode anti-sticking function. Compact and lightweight, ideal for home maintenance jobs, light carpentry and maintenance jobs.



1860BH

DC-powered inverter welding machine for MMA welding with rutilic, basic and stainless steel electrodes.



Arc force, hot start, anti-sticking and thermostatic protection features.

COMPACT AND EASY TO CARRY

Supplied with 16mm² cables



1860BH/120A 📞 018600121

£ 458,00 **£ 229,00**

1860BH/160A 📞 018600161

£ 591,00 **£ 295,50**

1860BH/200A 📞 018600201

£ 597,00 **£ 305,00**

Adjustment current	10÷120A	10÷160A	10÷200A
Power supply	1x230V	1x230V	1x230V
Use factor (40 °C)	25% - 120 A 50% - 80 A 100% - 60 A	25% - 160 A 60% - 100 A 100% - 80 A	25% - 200 A 60% - 130 A 100% - 100 A
Protection	IP22S	IP22S	IP22S
Usable electrodes	Ø 1.6 - 3.2 mm rutilic, basic, stainless steel, cast iron etc.	Ø 1.6 - 4 mm rutilic, basic, stainless steel, cast iron etc.	Ø 1.6 - 4 mm rutilic, basic, stainless steel, cast iron etc.
Dimensions	290x120x210 mm	290x120x210 mm	290x120x210 mm
Weight	3,5 kg	3,7 kg	3,9 kg



7245BK



7042LCD

070420001

£ 258,00 ~~£ 117,00~~



Auto-darkening LCD mask, for electrode welding; MIG/MAG; TIG and plasma.
Solar cells power supply and lithium batteries for outstanding LCD filter life

- Viewing area: 98x43 mm
- Darkening shade: DIN 9-13, externally adjustable
- UV/IR protection
- Light to dark time: 1/25000 s
- Dark to light time: 0.25-1s
- Adjustable darkening sensitivity and delay
- Auto on/off
- Grinding feature
- Optimized shape to make it easier to breathe with pulled-down screen



7043

070430001

£ 133,00 ~~£ 60,00~~



Auto-darkening LCD mask, for electrode welding, MIG/MAG, TIG and plasma, solar cell power supply

- Viewing area: 92x43 mm
- Darkening shade: DIN 9-13, externally adjustable
- UV/IR protection
- Light to dark time: 1/1000 s
- Dark to light time: 0.1-1.0 s
- Adjustable darkening delay
- Auto on/off
- Grinding feature
- Optimized shape to make it easier to breathe with pulled-down screen



1860BHT/KT

018600680

NEW!

£ 1.360,00 ~~£ 680,00~~



DC-output welding machine kit, for MMA and TIG electrode welding, TIG welding torch included

Arc force, hot start, anti-sticking and thermostatic protection features.



Supplied with 25 mm² cables



7041LCD/4S

070410001

£ 385,00 ~~£ 166,00~~



Auto-Darkening LCD mask, for electrode welding; MIG/MAG; TIG and plasma. 4 sensors with TRUE COLOR filter.
Solar cell power supply and lithium batteries for outstanding LCD filter life

- Viewing area: 98x80 mm
- Darkening shade range: 5÷8.5/ 9-13, internally adjustable
- UV/IR protection: DIN16
- Light to dark time: 1/25000 s
- Dark to light time: 0.1-2.0s
- Adjustable darkening sensitivity and delay
- Auto on/off
- Grinding feature
- Low battery indicator
- Ergonomic design, lightweight, well-balanced
- With adjustable ring nut



Adjustment current	10÷160A
Power supply	1x230V
Use factor (40 °C)	35% - 160 A
	60% - 130 A
	100% - 95 A
Protection	IP23S
Usable electrodes	Ø 1,6 - 4 mm rutilic, basic, stainless steel
Dimensions	360x140x230 mm
Welding machine weight	6,2 kg
Torch length	4 m



1860M

018600301

£ 121,00

£ 60,50

Magnetic, quick-adjusting corner welding vices

Strong magnets for immediate clamping of metallic parts to be welded

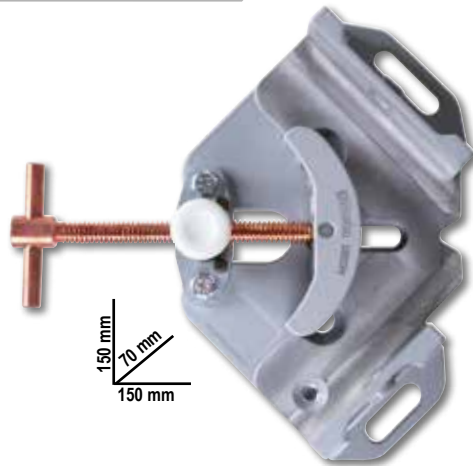
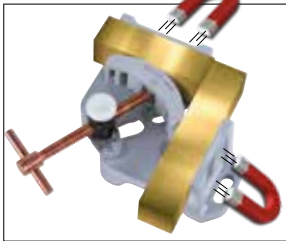

**SWINGING JAWS
IDEAL FOR
LOCKING DIFFERENTLY
SIZED PARTS**



1860RG

018600255

£ 78,00

£ 39,00

Adjustable magnetic square, 30°÷270°

- Ideal for locking tubular or flat parts
- 15 kg magnetic force
- Supplied with an offset hexagon key wrench for locking angle adjustment mechanism
- Supplied with a pin for locking angle adjustment mechanism at 30°-45°-90°/270°-180°
- With hexagon hole making it easier to separate magnet from metal



1860SQ

018600210

£ 117,50

£ 58,75

Magnetic square, 45°/90°

- Ideal for locking tubular or flat parts
- 25 kg magnetic force
- No battery required, ON/OFF effect obtained by tilting interior magnets
- Easier chip removal with magnets in OFF position



45°/90°
25 kg



1827/K

018270100

£ 271,00

£ 123,00

Gas soldering iron with 7 accessories in case with soft polyethylene foam base

- Power: 30 watts to 125 watts
- Tip temperature can be adjusted between 250 °C and 500 °C
- Gas flow regulator
- Warm-up time: 15 seconds
- Tank contains gas for 120 minutes' non-stop operation
- Clear tank for monitoring gas level
- Can be refilled with butane gas



332 003320001 ~~£ 24,40~~ **£ 10,50**

Mini pipe cutter for copper and light alloy pipes

L mm	Ø mm "
59	3÷16 1/8"÷5/8"



342 003420030 ~~£ 65,50~~ **£ 29,00**

Ratchet-type shears for plastic pipes



Ø 0÷42 mm
1"5/8

361N 003610014 ~~£ 104,00~~ **£ 47,00**

Adjustable lever pipe wrench

- Fast and easy one-handed operations
- Heavy duty model
- Self-locking/adjusting type

L mm	Ø max "	Ø max mm
350	1" 1/2	49



363

Heavy duty pipe wrenches made from light alloy



	L mm	Ø "	Ø mm		£
363 350	350	2" gas	60	003630035	£ 84,50 £ 38,00
363 450	450	2 1/2" gas	76	003630045	£ 116,00 £ 53,00
363 600	600	3" gas	90	003630060	£ 197,00 £ 89,00
363 900	900	5" gas	140	003630090	£ 369,00 £ 159,00
363 1200	1200	6" gas	165	003630120	£ 383,00 £ 165,00

1750KG10 017500100

~~£ 270,00~~ **£ 116,00**

Lever-operated grease gun, 10 kg, with high-pressure hose, 2 m

- Complete with swivel fitting, to avoid choking hose
- Die-cast aluminium pump body with check valve

3 different pressure levels available:

- 4 g at 275 bar
- 7 g at 206 bar
- 9 g at 137 bar



312,5 mm

1750 017500500

~~£ 49,50~~ **£ 23,00**

Lever operated grease guns, 500 cc



550 BAR

1599F

Parallel bench vices, forged

- Fully steel cast
- Milled and hardened jaw surface
- Front opening
- High clamping depth

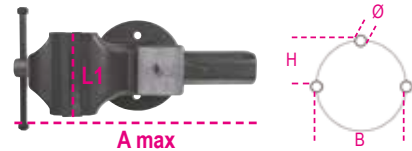

1599G

Pairs of aluminium jaw covers



	L1 mm	BxH mm	Ø mm	A max mm	Art. No.	£	£
1599F 100	100	92x46	11	125	015990100	£ 400,00	£ 172,00
1599F 125	125	108x54	13	150	015990125	£ 535,00	£ 230,00
1599F 150	150	125x62	13	200	015990150	£ 720,00	£ 313,00
1599F 175	175	140x70	15	220	015990175	£ 950,00	£ 412,00

	Art. No.	£	£
1599G 100	015990910	£ 71,50	£ 31,00
1599G 125	015990912	£ 74,50	£ 32,00
1599G 150	015990915	£ 77,00	£ 33,00
1599G 180	015990917	£ 80,50	£ 34,50

1852R1750 018520175

~~£ 2.140,00~~ **£ 920,00**

Portable induction heater

- Heats and loosens stubborn bolts, hubs and bearings without using flames
- Allows any type of ferromagnetic metal to be heated

Technical data:

- Input voltage: 230V AC, 50/60 Hz
- Input current: max. 7.5 A
- Power: max. 1.75 kW

BENEFITS

- 1 Time saving: quick, extremely accurate heating
- 2 Fire safety: does not produce flames, maximum operator safety
- 3 Functional: can be used with one hand, and coils can be easily interchanged

FIELDS OF APPLICATION

- Automotive industry
- Industrial maintenance
- Aviation industry
- Naval industry
- Petrochemical industry



**MAXIMUM SAFETY
WITHOUT USING FLAMES**



Standard equipment:

Two front attachable coils, Ø 19 and 26 mm, for loosening nuts



One flat coil for heating surfaces



One flexible coil, 800 mm long



480x370x130 mm

1149F 011490010

~~£ 23,50~~ **£ 11,00**

Front wire stripping pliers with cutting blade, self-adjusting

- Self-adjustment to wire diameters
- Adjustable stripping length
- Insulating cutting pressure adjustment
- Built-in cutting device

0,2÷6 mm²



1609B 016090101

~~£ 403,00~~ **£ 173,00**

Mechanical crimping pliers

- For noninsulated copper terminals, 10÷120 mm²
- Antislip rubber handle
- Internal "H" section pin for unparalleled punch smoothness
- Made from burnished steel



10÷120 mm²



L 600 mm

1740B

Compact heavy-duty riveting pliers

- Optimized lever ratio for increased compactness and handiness.
- 3 jaws lock rivet for a perfect grip.
- Adjustable head for pulling rivet by 2 to 5 leg movements.



	mm steel		£
1740B 280	2,4÷4,8	017400280	£ 91,50 £ 41,00
1740B 330	2,4÷6,4	017400330	£ 100,00 £ 45,00

1741U

017410450

~~£ 60,00~~

£ 26,00

Ultra compact riveting pliers with adjustable force with 4 interchangeable nozzles



Ø mm	2,4	3	3,2	4	4,8
Aluminium	•	•	•	•	•
Steel	•	•	•	•	
Inox	•	•	•	•	

1741B

017410000

~~£ 54,50~~

£ 23,50

Riveting pliers supplied with 4 interchangeable nozzles



Ø mm	2,4	3,2	4	4,8/5
Aluminium	•	•	•	•
Steel	•	•	•	•
Inox	•	•	•	

1870I

018700220

~~£ 338,00~~

£ 152,00

Solid and fluid vacuum cleaner, 20 l, stainless steel drum

TECHNICAL SPECIFICATIONS:

- single-stage by-pass motor
- voltage: 230/240 V
- frequency: 50/60 Hz
- max. power: 1200 W
- airflow rate: 58 l/sec.
- max. suction pressure: 190 mbar
- max. drum capacity: 20 l, made of stainless steel
- acoustic emissions: <70 dB(A)
- cable length: 5 m

STANDARD ACCESSORIES Ø 36 mm

- 1 corrugated hose with ergonomic handle and vent
- 2 hard extension tubes
- 1 multiuse brush for floors and fluids
- 1 flat nozzle
- 1 paper bag

FILTERING SYSTEMS

- 1 surface air filter cartridge 1900 cm² - 12 µm nom.
- 1 anti-foam filter PPI 45/PPI 30



1749A

017490010

~~£ 53,50~~

£ 24,00

Bonding gun, professional model aluminium tube



1749AC

017490005

~~£ 49,00~~

£ 22,00

High thrust gun for chemical binders



1833

High-brightness LED torch, made of sturdy anodized aluminium

- Adjustable focus
- 2 brightness settings



Battery life 10.0 h - L 150 mm

1833 S 018330002 ~~£ 47,50~~ **£ 22,00**

Battery life 7.5 h - L 162 mm

1833 M 018330003 ~~£ 58,50~~ **£ 28,00**

1833 L/USB 018330054 ~~£ 152,00~~ **£ 76,00**

Rechargeable high-brightness LED torch, made of sturdy anodized aluminium, up to 1,200 lumens

- Adjustable focus
- 3 brightness settings
- Battery life: 3.0h
- Charging via USB-C port
- Charger not included



1838SLIM 018380221

~~£ 77,00~~ **£ 37,00**



Rechargeable, articulated slim 3-LED inspection lamp

- Magnetic base
- Charging time: 2.5h
- Battery life: 2-4h/ spot 3h

Triple light emission

- front: 100/200 lumens
- back: 180 lumens
- spot (head): 80 lumens



307x29x17 mm

L 307 mm



1838AM 018380400

~~£ 143,00~~ **£ 64,00**



Rechargeable LED inspection lamp, with double light emission, articulated, can be rotated 180°, with swivel magnetic base and hook

- **Double light emission:** front: LED COB, 60-700 lumens, can be adjusted with potentiometer spot (head): LED SMD, 120 lumens, ON-OFF switch
- Rechargeable 3.6V 2600mAh Li-ion battery
- With USB-C port
- Supplied with 100-240V / 50-60Hz charger
- Charging time: 4h
- Battery life: front: 2.5-16h spot (head): 10h
- 3-LED battery level indicator
- Articulated, can be rotated 180° (± 90° compared to axis)
- Magnetic base (with neodymium magnet), can be rotated 90°
- Swivel base hook
- IP54
- IK07

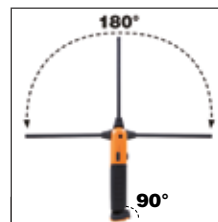

L 405 mm



1837C

Rechargeable LED spotlight for building yards

- 3 brightness settings
- battery charger:
input: 100-240V AC - 50/60Hz;
output: 15V 1.5A
- charging time: 4 hours
- 3-LED charge indicator
- can rotate up to 180°
- IP65
- IK07



1837C/2100

018370210

£ 226,50 **£ 102,00**



220x225x70 mm

500/1000/2100 lumen

1837C/4300

018370430

£ 339,00 **£ 153,00**



266x236,6x59 mm

1100/2100/4300 lumen

1838FLASH

018380300

£ 476,00 **£ 205,00**

Rechargeable, ultracompact spotlight, designed to offer the best possible solution for each use

- IP65 - without external power supply
- Dual brightness: 300/720 lumens
- Lithium polymer battery 7.4 V 4000 mAh



4-8h

85x100x155 mm

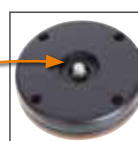

1838COB

018380010

£ 134,00 **£ 58,00**

Compact rechargeable inspection lamp with ultra-brightness LED

- Lithium polymer battery
- Compact body made of antislip rubber
- Swinging hook
- Magnetic base can be rotated 180 degrees
- With charger 100-240Vac / 50-60Hz
- 100/200 lumens - spot 75 lumens
- Operating range: 5 / 2.5 hours
- IP65



120x59x25 mm

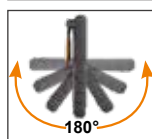

1838/11LED

018380111

£ 211,00 **£ 91,00**

Rechargeable inspection lamp with ultra-high brightness LEDs, lithium polymer battery

- Compact body made of antislip rubber
- With charging station, 110-230Vac



With multidirectional head LED



With head LED



<20%



Swinging hook



1838E

018380270

£ 246,00 **£ 111,00**

Rechargeable under bonnet LED lamp

- Triple light emission: 500/1000/2000 lumens
- Can be rotated 360°
- Length range: 116 ÷ 188 cm
- Aluminium body
- Non-slip rubber hooks
- USB-C charge
- Supplied with battery charger
Input: 100-240V ~ 50/60Hz
Output: DC 5V - 2000 mA
- Battery life: 3-9 h
- IP20 • IK07



- 2 charging modes:
- charge via lamp USB port
 - charge via internal battery USB port



1838E-BT

018380271

£ 69,50 **£ 30,00**

Rechargeable battery with USB-C port for under bonnet lamp item 1838E

- Li-Ion 3,6V
- DC 5V - 2000 mA

WIRELESS RECHARGEABLE

1833XSW

018330011







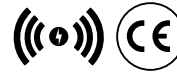



~~£ 54,50~~ **£ 25,00**

LED inspection torch, wireless rechargeable

- Two brightness settings: LED SMD, 250 - 80 Lumen
- Rechargeable battery: 3.7V 700 mAh., 2.59 Wh Li-ion
- Two charging modes:
 - wireless base 1839BRW
 - power supply with USB-C port
- Charging time:
 - 2h with wireless charging base
 - 2h with power supply
- Battery life: 2-8h
- LED battery level indicator
- Magnets on base and back
- Belt clip
- USB-C cable included
- IP54
- IK07



NEW!

 80/250 lumen	 SMD
 2 h	 Wireless: 2 h
 2-9 h	 700 mAh Li-ion 3.7 V
 -10°C + 40°C	
 145x25x21 mm	 IP54

1833MW

018330013







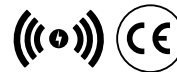



~~£ 100,00~~ **£ 45,00**

High-brightness LED torch, wireless rechargeable

- Four brightness settings: LED SMD, 1000 - 400 - 30- 5 Lumen
- Rechargeable battery: 3.7V 2600 mAh, 9.62 Wh Li-ion
- Two charging modes:
 - wireless base 1839BRW
 - power supply with USB-C port
- Charging time:
 - 6h with wireless charging base
 - 4h with power supply
- Battery life: 2-200h
- 3-LED battery level indicator
- Magnet on back
- USB-C cable included
- IP68
- IK07



NEW!

 1000-400-30-5 Lumen	 SMD
 4 h	 Wireless: 6 h
 2-200 h	 2600 mAh Li-ion 3.7 V
 -10°C + 40°C	
 40x40x160 mm	 IP68

1836AW









018360051

~~£ 72,00~~ **£ 37,00**

Rechargeable wireless LED headlamp, dual brightness

- Rechargeable battery: Li-Ion 3.7 V, 1500 mAh, 5.55 Wh
- USB-C port
- Supplied with USB-C cable
- Charging time:
 - 2.5 h with power supply
 - 4.5h with wireless charging base
- Battery life:
 - front: 4-18 h
 - head (spotlight): 4 h
- IP65
- IK07



 Front: 30/200/400 lumen Spot: 400 lumen	 Front: COB LED Spot: COB LED
 2,5 h	 Wireless: 4.5 h
 4-18 h Spot: 4 h	 Li-ion 3.7V 1500mAh 5.55Wh
 70x52x45 mm	 IP65

- **Dual light emission:**
 - front: 3 light intensities, LED COB, 30 - 200 - 400 lumens
 - head (spotlight): LED COB, 400 lumens

WIRELESS RECHARGEABLE

1838POCKET 018380080

£ 92,50 **£ 42,00**

Articulated pocket LED spotlight, with dual light beam and wireless charging

- Rechargeable 3.7V 2600mAh Li-ion battery
- 2 charging modes:
 - wireless 1839BRW base
 - power supply with USB-C port
- Charging time:
 - 4.5 h with wireless charging base
 - 4 h with power supply
- Battery life: - main light: 3-9h
- spot light: 4.5 h
- 3-LED battery level indicator
- Can be rotated 210°
- Nonslip rubber body
- Magnetic base
- 1 magnet on base
- Supplied with a USB-C cable
- IP65
- IK07



- **Dual light emission:**
 - main light: LED COB, 3 light intensities: 160 - 400 - 800 lumens
 - spot light: LED SMD, 250 lumens
- **Lighting angle:**
 - main light: 160°
 - spot light: 18°

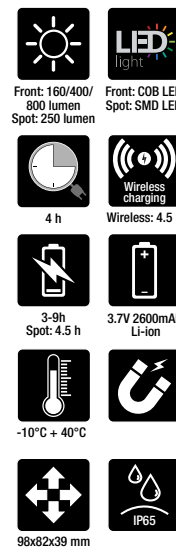

1838SW 018380142

£ 138,50 **£ 63,00**

Rechargeable, articulated LED inspection lamp and wireless charging

- Rechargeable 3.6V 3.350mAh Li-ion battery
- 2 charging modes:
 - wireless 1839BRW base
 - power supply with USB-C port
- Charging time:
 - 6.5h with wireless charging base
 - 4.5h with power supply
- Battery life: - front: 3-5h
- spot (head): 7h
- 3-LED battery level indicator
- Base can be rotated 180°
- Nonslip rubber body
- Double swinging hook
- Magnets on base and back
- IP65
- IK07



- **Dual light emission:**
 - front: LED COB, 3 light intensities: 250 - 500 - 1000 lumens
 - spot (head): LED SMD, 200 lumens

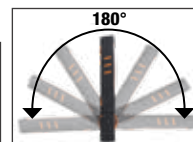

1839BRW 018390002

£ 136,50 **£ 62,00**

Wireless charging base, compatible with 1838POCKET, 1838SW, 1836AW, 1833XSW, 1833MW inspection lamps

- Two charging positions with magnetic connection, for simultaneous use
- With pull-out support for wireless mobile phone charging
- Charging status LED indicator
- Max. input: 10W x2
- Input: AC 100-240V 50/60Hz
- Output: DC 12V 1.5A
DC 9V 2A
DC 5V 3A
- USB-C port
- IP20
- IK07



- **Can be hung on wall through:**
 - 3 strong magnets on back
 - 2 screw holes

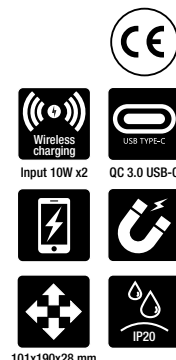

THE RANGE OF REELS

Beta's wide, complete range of reels has been designed and developed to satisfy all professionals' requirements. High-resistance spring ensuring remarkable durability and fluidity in use. Shells made of thick polypropylene, for unique shock resistance. Rack device causing automatic cable rewind to stop, easy to disable, to allow continuous traction. Each reel is fitted with a 180° swivel wall-mount bracket and an additional bracket for quick connection and disconnection from the wall-mount support.

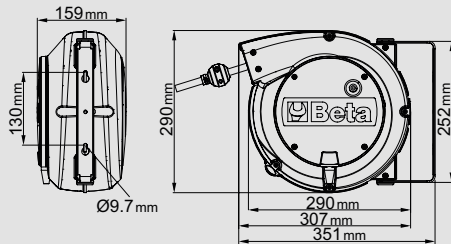

- Length of cable out of shell: 1 m
- Rack mechanism can be disabled to keep cable in traction
- Coiled cable length: 15 m



1842 15-H05/LED 018420821

~~£ 507,00~~ **£ 218,00**

Automatic cable reel with LED inspection lamp, 100-240Vac

- With 230/12V safety transformer
- H05VV-F 2x1.0 mm² cable



1844 15-H05 018440315

~~£ 271,00~~ **£ 123,00**

Automatic cable reel, with 3Gx1.5 mm² cable

- 3Gx1.5 mm² cable
- With thermal protection switch
- Max. power (rolled up): 1500W (230V-20°C)
- Max. power (unrolled): 2500W (230V-20°C)



1844 15-H05/SCK 018440316

~~£ 318,00~~ **£ 144,00**

Automatic cable reel, with 3Gx1.5 mm² cable and SCHUKO type socket and plug

- 3Gx1.5 mm² cable
- With thermal protection switch
- Max. power (rolled up): 1500W (230V-20°C)
- Max. power (unrolled): 2500W (230V-20°C)



1845 15-H07 018450367

~~£ 655,00~~ **£ 282,00**

Automatic cable reel, with 3Gx2.5 mm² cable

- 3Gx2.5 mm² cable
- With thermal protection switch
- Max. power (rolled up): 2000W (230V-20°C)
- Max. power (unrolled): 3000W (230V-20°C)



1273MQ/D6 012730851

~~£ 93,00~~ **£ 40,00**



Set of 6 screwdrivers

1274MQ ● 3x100-4x100-5,5x125 mm
1272MQ ⊕ PH0x60-PH1x80-PH2x100 mm

EN 60900



1273MQF/D6 012730606

~~£ 100,00~~ **£ 43,00**



Set of 6 slim screwdrivers

1274MQ/F ● 0,5x3,5x100 - 0,8x4,5x100 -
1x5,5x125 - 1,2x6,5x150 mm
1272MQ/F ⊕ PH1x4,5x80- PH2x6x100 mm

EN 60900



1169MQ/D2 011690152

~~£ 131,00~~ **£ 56,00**

NEW!

Assortment of insulated combination pliers and insulated diagonal cutting nippers

EN 60900



1082MQ 160 mm

1150MQ 180 mm

914MQ-A/S4 009140054

~~£ 85,50~~ **£ 37,00**

Set of hexagon hand sockets, 3/8" female drive

Made from special polyamide-based technopolymers

3/8"

For use with torque wrench

○ mm	max (Nm)
8	6
10	9
13	20
17	30



EN 60900



2001/BZ24 MQ 020010154

~~£ 427,00~~ **£ 184,00**

Folding tool case with assortment of 24 tools, for electricians



380x290x60 mm

24



1128MQ 011280101

~~£ 72,50~~ **£ 31,00**

Electrician's scissors, stainless steel blades, with microteeth

IEC 60900



Quantity/Description

1 electrician's scissors, straight blades	Beta N.
1 combination pliers 1000V ≡ 180 mm	1128BMX
5 combination wrenches 8-10-13-17-19 mm	1150MQ
3 screwdrivers for headless slotted screws, 1000V	42
● 3x100 - 4x100 - 5,5x125 mm	1274MQ
3 screwdrivers for cross head Phillips® screws, 1000V	1272MQ
⊕ PH0x60 - PH1x80 - PH2x100 mm	
9 ball head offset hexagon key wrenches burnished	96BP/SC9
○ 1,5-2-2,5-3-4-5-6-8-10 mm	
1 mains testing screwdriver ●	1253
1 diagonal cutting nippers 1000V ≡ 160 mm	1082MQ

1760/OHM 017600025

£ 1.188,00 **£ 510,00**

Multimeter/megohmmeter for high voltage insulation testing TRUE RMS indicator



CAT. IV 600V
CAT. III 1000V



AC/DC voltage:	50mV - 1000V	Measuring range	Base accuracy
AC/DC current:	0.01µA - 10A	Resistance:	±0.06% - ±0.1% rdg
Resistance:	0.01Ω - 50MΩ	Meg OHM:	±0.5% - ±1% rdg
Meg OHM:	0.01 - 5000MΩ	Capacity:	±0.2% - ±2% rdg
Capacity:	5nF - 10mF	Frequency:	±4% rdg. max current 1mA
Frequency:	50Hz - 100 MHz	Temperature:	±1.5% - ±3% rdg
Temperature:	-50 °C - +1350 °C	Diode test:	±0.02% - ±0.1% rdg
Diode test:	3V dc	Continuity test:	±0.5% rdg
Continuity test:	<30 Ω		

2029EM 020290300

£ 2.630,00 **£ 1.130,00**

Tool case with assortments of 43 maintenance and repair tools for hybrid and electric vehicles



490x380x230 mm



43

NEW!

Quantity/Description	Beta N.
13 single open end wrenches, 1000V 7-8-9-10-11-12-13-14-15-16-17-19-22 mm	52MQ
7 bi-hex sockets ○ 6-7-10-12-13-17-19 mm	910MQ/B
3 socket drivers for Torx® head screws ⊕ TX25-TX30-TX40	910MQ/TX
1 3/8" drive reversible ratchet	910MQ/55
1 slip joint pliers, boxed joint 250 mm	1048MQ
1 diagonal cutting nippers 1000V ⚡ 160 mm	1082MQ
1 electrician's scissors 145 mm	1128MQ
1 combination pliers 1000V ⚡ 180 mm	1150MQ
1 extra long flat nose pliers ⚡ 160 mm	1162MQ
2 screwdrivers for cross head Phillips® screws, 1000V ⊕ PH1 - PH2	1272MQ
5 screwdrivers for headless slotted screws, 1000V ● 2,5x75 - 3x100 - 4x100 - 5,5x125 - 6,5x150 mm	1274MQ
1 combination voltage and continuity tester	1760PT
1 cable stripping knife, insulated 190 mm	1777MQ/U
1 composite insulating gloves GM 10	1996MQ/GM
2 aluminium warning signs A1 - A2	7109A
2 prohibition signs D2 - D3	7109D

2400 RSC24/6-VEM 024004016

£ 7.680,00 **£ 3.270,00**

Mobile roller cab with 6 drawers and assortment of 81 repair and maintenance tools for hybrid and electric vehicles



RSC24/6-R 6

Quantity/Description

1 insulating mat	1995MQ/T	TR
4 plastic posts with fillable bases	7104 90	
1 multimeter/megohmmeter for high voltage insulation testing	1760/OHM	
1 combination voltage and continuity tester, 12-690V AC/DC	1760PT	
1 spare leads for digital multimeters and amperometric clamps	1760DGT-R3	
1 composite insulating gloves	1996MQ/GM	
1 plastic barrier chain	7105 6	
2 aluminium warning signs	7109A	
2 prohibition signs	7109D	
12 single open end wrenches, 1000V 7-8-10-11-12-13-14-15-16-17-19-22 mm	52MQ	M49
12 single ring wrenches 7-8-10-11-12-13-14-15-16-17-19-22 mm	89MQ	M49
4 socket drivers for hexagon screws ○ 4-5-6-8 mm	910MQ/PE	M108
11 bi-hex sockets ○ 7-8-10-11-12-13-14-15-16-17-19 mm	910MQ/B	M108
6 socket drivers for Torx® head screws ⊕ T15-T20-T25-T27-T30-T40	910MQ/TX	M108
2 socket drivers with XZN® profile ○ 8-10 mm	910MQ/XZN	M108
1 3/8" drive extension 125 mm	910MQ/21	M108
1 3/8" drive extension 250 mm	910MQ/22	M108
1 3/8" drive, T-handle	910MQ/T	M108
1 3/8" drive reversible ratchet	910MQ/55	M108
1 electrician's scissors	1128MQ	M161
1 slip joint pliers, boxed joint 250 mm	1048MQ	M161
1 diagonal cutting nippers 1000V ⚡ 160 mm	1082MQ	M161
1 combination pliers 1000V ⚡ 180 mm	1150MQ	M161
1 extra long flat nose pliers ⚡ 160 mm	1162MQ	M161
1 extra-long bent flat nose pliers ⚡ 160 mm	1164MQ	M161
4 screwdrivers for cross head Phillips® screws, 1000V ⊕ PH0x60 - PH1x80 - PH2x100 - PH3x150 mm	1272MQ	M161
4 screwdrivers for headless slotted screws, 1000V ● 2,5x75 - 3x100 - 4x100 - 5,5x125 mm	1274MQ	M161
1 cable stripping knife, insulated	1777MQ/U	M161



24

M49

27

M108

15

M161

MULTIPURPOSE TOOL COMPLETE WITH BITS AND SHEATH

1778MT

BETA's multipurpose tool stands out from similar commercially available tools with BETA's typical hallmarks: pliers synonymous with matchless quality, sophisticated materials and state-of-the-art technology. The 11 bits, which come in the most popular geometries in the market, make this item ideal for any work environments and conditions, e.g. camping, nautical industry, hunting and DIY.

1778MT 017780055

~~£ 126,50~~ **£ 57,00**

Multi-tools complete with bits and sheath

9 tools for a total of 22 functions:

- Combination pliers
- Large blade
- Corrugated blade
- Hacksaw frame
- File
- Tin/Bottle opener
- Scissors
- Bit holder
- Screwdriver for cross head Phillips® screws



SUITABLE FOR EVERY SITUATION!



Easy pull-out of tools



Tool unlock buttons



11 bits + socket + tweezers



Ruler 100 mm + Ruler, 4"

COMPACT AND VERSATILE!



1103 950 011030090

~~£ 196,50~~ **£ 85,00**

Flat hat bolt cutter for rod irons, bolts and electrowelded mesh for concrete reinforcement

Cutting capacity:

- Ømax = 12 mm
- Ømax (HRC 48)= 6 mm



L 950 mm

Lever handles with ergonomic angles to minimize efforts

1726BM 017260050

~~£ 68,00~~ **£ 30,00**

Hacksaw frame with quick release blade attachment system

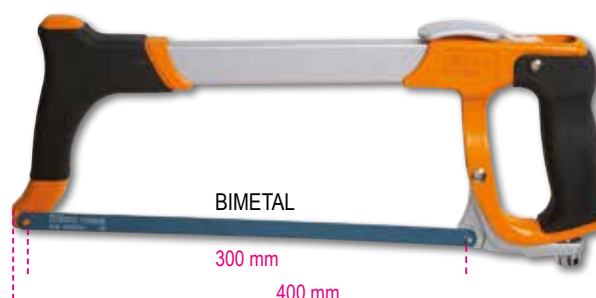

BIMETAL

300 mm

400 mm

1128FX 011280090 ~~£ 37,50~~ **£ 16,00**

Electrician's scissors, straight stainless steel blades, with microteeth, cable cutting groove and crimping pliers for tube terminals

- Articulated belt hook case
- Bimaterial handles
- Anti-loose pin



1128BAX 011280088 ~~£ 40,00~~ **£ 17,00**

Double-acting electricians' scissors, with milling profiles in DLC-coated stainless steel

- High blade surface hardness (resistance to abrasion and wear)
- Low coefficient of friction (smoothness and anti-adherence)
- With articulated plastic case

**+HARDNESS
-COEFFICIENT
OF FRICTION**

Profile and mill: designed to enlarge holes on plastic, from 13 to 25 mm.



1778BS 017780035 **NEW!**
~~£ 41,00~~ **£ 21,00**

Foldaway knife with serrated blade, in wallet

- Stainless steel serrated blade
- Carbon look finish
- Double safety blade lock
- Lightweight fibreglass handle
- Complete with hole for locking/unlocking shackles for nautical applications
- With clip and fabric wallet with loop



1773S 017730100 **NEW!**
~~£ 9,90~~ **£ 4,25**

Safety utility knife with round blade

- Main blade Ø 28 mm
- Secondary blade for cutting films
- Hanging hook



1772M 017720040
~~£ 26,50~~ **£ 12,00**

Safety utility knife with retractable blade, supplied with 3 blades

- Blade retracts through an automatic spring mechanism
- Die-cast alloy body
- Staple remover built into handle



**ADJUSTABLE CUTTING
DEPTH Ø ÷ 25 mm**

1771 017710000
~~£ 12,30~~ **£ 5,30**

Utility knife, 18 mm, supplied with 3 blades





1972/K12V-10

019720112

£ 288,00 **£ 130,00**

NEW!



316x254x96 mm

2,3 kg

Ultracompact drill, 12V

Ultracompact: no more than 170 mm in length;
Ultralightweight: no more than 1.1 kg, with battery, and perfectly balanced

Features:

- Double mechanical speed with steel gears and 20-position clutch
- Torque up to 30 Nm and 1300 rpm (400 rpm in 1st gear); drills diameters up to 10 mm in steel and 20 mm in wood
- 2Ah batteries and charge indicator on drill body
- Ergonomic nonslip handle
- Front LED
- 10-mm self-locking chuck
- Belt clip (right/left side)
- Selector switch, screwing-unscrewing-locking modes (for transportation)
- **Supplied in a hard case with 2 lithium ion batteries (2 Ah) and quick charger (50 min)**



Beta
3-YEAR WARRANTY



1982/K12V

019820112

£ 288,00 **£ 130,00**

NEW!



316x254x96 mm

2,3 kg

Reversible impact wrench, 12V,

ideal for jobs in small areas, provides high torque (80 Nm), one-handed operation

Ultracompact: no more than 160 mm in length;
Ultralightweight: no more than 1 kg, with battery, and perfectly balanced

Features:

- 1/4" hexagon drive with locknut
- Belt clip (right/left side)
- Front LED
- Selector switch, screwing-unscrewing-locking modes (for transportation)
- Ergonomic nonslip handle
- Gearcase made entirely of metal
- 2Ah batteries with charge indicator on impact wrench body
- **Supplied in a hard case with 2 lithium ion batteries (2 Ah) and quick charger (50 min)**



Beta
3-YEAR WARRANTY



1972/K12V-COMBO

019720010

£ 488,00 **£ 221,00**

NEW!



3 kg

310x295x100 mm

12V kit of ultracompact drill + 1/4" HEX reversible impact wrench

Case contents:

- 1x12V ultracompact drill, with 10-mm autochuck
- 1x12V reversible impact wrench, with 1/4" hexagon drive
- 2x2Ah lithium ion batteries
- 1 quick battery charger



+

Beta
3-YEAR WARRANTY



THE RANGE OF BETA-BRANDED ANGLE GRINDERS

Power, Reliability and Durability are the three hallmarks of the new range, with the focus also being on maximum safety and ease of use for professionals.

- **Outstanding performance:**
 - Powerful, resin-bonded, wear-resistant, durable motor
 - Air vents providing optimal cooling, protected against dust infiltration
- **Unparalleled safety for operators:**
 - Spindle lock device for quick disc changes
 - Protection against accidental activation
 - Smooth start, for limiting large initial inrush of current on start-up
- **Unique comfort and ease of handling:**
 - Nonslip ergonomic handle for improved grip
 - Lowered head that allows working in confined spaces
 - Tangle-free cable no less than 4 metres in length for increased ease of movement
 - Additional handle that can be mounted on both sides

Available for discs 115/125/230 mm in diameter, rated absorbed power ranging from 750 W to 2400 W.



1956 115-750W

019560011

~~£ 106,00~~

£ 45,50

4 m



Angle grinder for discs Ø 115 mm

Ideal for cutting, grinding and roughing jobs

Powerful motor (750 W)

- Nonslip ergonomic handle for increased comfort and safety
- Lowered head that allows working in confined spaces
- Extremely lightweight (**weighs no more than 1.8 kg**)
- Tool-less disc cover (quick release)
- Additional handle that can be mounted on both sides



750W

Technical data

- Absorbed power: 750 W
- Voltage: 220-240 V / 50 Hz
- Disc diameter (disc not included): 115 mm
- Free speed: 11,000 rpm
- Tool spindle thread: M14
- Tangle-free cable length: 4 m
- Weight: 1.8 kg

1956 125-1400W

019560125

~~£ 205,50~~

£ 88,00

4 m



Angle grinder for discs Ø 125 mm

Ideal for cutting, grinding and roughing jobs

Powerful motor (1400 W) - Variable speed

- Nonslip ergonomic handle for increased comfort and safety
- Lowered head that allows working in confined spaces
- Tool-less disc cover (quick release)
- Additional anti-vibration handle that can be mounted on both sides

VARIABLE SPEED



1400W

Technical data

- Absorbed power: 1400 W
- Voltage: 220-240 V / 50 Hz
- Disc diameter (not included): 125/115 mm
- Free speed: 3,000 - 10,000 rpm
- Tool spindle thread: M14
- Tangle-free cable length: 4 m
- Weight: 2.5 kg

1956 230-2400W

019560230

~~£ 277,00~~

£ 119,00

4 m



Angle grinder for discs Ø 230 mm

Ideal for complex shearing, grinding and filing jobs

Powerful motor (2400 W)

- Nonslip ergonomic handle for increased comfort and safety
- **Soft-start function** for a smooth start and limiting large initial inrush of current on start-up anti-vibration
- Spindle lock device for quick disc changes



2400W

Technical data

- Absorbed power: 2400 W
- Voltage: 220-240 V / 50 Hz
- Disc diameter (not included): 230 mm
- Free speed: 6,500 rpm
- Tool spindle thread: M14
- Tangle-free cable: 4 m
- Weight: 5.8 kg

SPECIAL PROMOTION

**Purchase 250 cutting discs, Ø 125 mm,
and you will get a grinder for free**

Beta 1956 125-1400W

Angle grinder

- Powerful motor (1400W) - Variable speed
- Nonslip ergonomic handle for increased comfort and safety
- Lowered head that allows working in confined spaces

Main features

- Protection against accidental activation
- Additional anti-vibration handle that can be mounted on both sides
- Tool-less disc cover (quick release)
- Spindle lock device for quick disc changes
- Lock-on/off slide switch
- Air vents protected against dust infiltration and providing optimal cooling performance
- Service wrench included

Technical data

- Absorbed power: 1400 W
- Voltage: 220-240 V / 50 Hz
- Disc diameter (not included): 125/115 mm
- Free speed: 3,000 - 10,000 rpm
- Tool spindle thread: M14
- Tangle-free cable length: 4 m
- Weight: 2.5 kg



11035

Abrasive steel and stainless steel cutting discs, thin, with flat centre

- Ultra-high performance discs
- For universal use for cutting stainless steel, alloy steel, and treated/untreated steel
- High material removal combined with low disc wear
- Minimum heating of disc being worked
- Reduced burr production
- Reduced power absorption of electric tool
- Powerful electric tools should be used



11035 1,0/SM-EXP

Diameter x Thickness	N° pieces	Package Code	£ 993,00	£ 427,00
125 x 1,0	250	110350925	£ 993,00	£ 427,00

11035 1,6/SM-EXP

NEW!

Diameter x Thickness	N° pieces	Package Code	£ 993,00	£ 427,00
125 x 1,6	250	110350926	£ 993,00	£ 427,00

11001

Abrasive steel cutting discs, with depressed centre



A30S



Ø mm	S mm	F mm		£
115	3,2	22,23	110010118	£ 2,56 £ 1,28
230	3,2	22,23	110010233	£ 5,70 £ 2,85

11011

Abrasive steel grinding discs, with depressed centre



A24N



Ø mm	S mm	F mm		£
115	6,5	22,23	110110115	£ 3,45 £ 1,73
125	6,5	22,23	110110125	£ 3,65 £ 1,83
230	6,5	22,23	110110230	£ 9,30 £ 4,65

11045-11049

Abrasive steel and stainless steel cutting discs, thin, with flat centre



PREMIUM LINE



	Ø mm	S mm	F mm		£
11045	A46Q	115	1,0	22,23	110450010 £ 2,82 £ 1,41
11045	A46Q	115	1,6	22,23	110450016 £ 2,90 £ 1,45
11046	A46Q	125	1,0	22,23	110460010 £ 2,97 £ 1,49
11046	A46Q	125	1,6	22,23	110460016 £ 2,97 £ 1,49
11049	A36Q	230	2,0	22,23	110490019 £ 5,50 £ 2,75

11034-11038

Abrasive steel and stainless steel cutting discs, thin, with flat centre

Ultra-high performance discs
For universal use for cutting stainless steel, alloy steel,
and treated/untreated steel
Powerful electric tools should be used



A46U

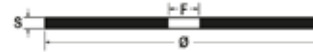

	Ø mm	S mm	F mm		£
11034	115	1,0	22,23	110340022	£ 2,82 £ 1,41
11034	115	1,6	22,23	110340062	£ 2,82 £ 1,41
11035	125	1,0	22,23	110350022	£ 3,15 £ 1,58
11035	125	1,6	22,23	110350062	£ 3,15 £ 1,58
11038	230	2,0	22,23	110380022	£ 5,95 £ 3,00

1898 40

☎ 018980040

£ 5.540,00 **£ 2.550,00**

Eco friendly, heated manual cleaning tank

- Using the bio-active liquid included, oil and residue can be effectively removed from mechanical parts without the need for aggressive chemicals
- The bio-active liquid converts the oil and other residue into carbon dioxide and water which can be re-used again and again
- No need for specialist waste collection and disposal
- Suitable for both metal and plastic parts

EQUIPMENT:

- Long bristle brush and connecting pipe
- Right-hand and left-hand operation function
- Perforated stainless steel grid
- Wheels with brakes
- Card with display operating temperature and low level alert

Max. pump capacity	10 l/min
Tank capacity	40 l
Operating temperature	+5°C ÷ +40°C
Weight	50 kg (when empty)
Internal dimensions	710x370x200 mm



NO DISPOSAL OF FLUIDS!



EFFECTIVE AND ENVIRONMENTALLY FRIENDLY

1895

Ultrasonic cleaning tank with special degas function

- Ultrasonic cleaning relies on fluid heating to effectively clean spare parts and metal pieces in general (carburetors, valves etc.)
- Digital display for temperature and cleaning time selection
- Two cleaning modes: "soft" and "normal"
- For normal cleaning, just use water at a temperature of 50/60 °C
- For more accurate cleaning, add non-foaming detergent solutions specific for ultrasonic tanks
- Using the degas mode speeds up air release throughout the tank, thereby improving ultrasonic cleaning efficiency



1895 6 ☎ 018950060 **6 l**

£ 1.001,00 **£ 430,00**

1895 13 ☎ 018950130 **13 l**

£ 1.520,00 **£ 655,00**

1895 27 ☎ 018950270 **27 l**

£ 2.155,00 **£ 925,00**

1895 6 1895 13 1895 27

	6 l	13 l	27 l
Tank capacity	6 l	13 l	27 l
Drain tap	✓	✓	✓
Power	150 Watt	300 Watt	500 Watt
Heating power	300 Watt	400 Watt	500 Watt
Temperature range	0+80°C	0+80°C	0+80°C
Cleaning time range	0-99 minutes	0-99 minutes	0-99 minutes
Frequency	40 kHz	40 kHz	40 kHz
Power supply	220/230V	220/230V	220/230V
Dimensions	330x180x310 mm	350x325x320 mm	530x330x380 mm
Tank size	300x155x150 mm	325x235x145 mm	500x300x200 mm

1498/8A 014980108 ~~£ 388,00~~ **£ 139,00**

Electronic car / commercial vehicle battery charger, 12 V

- Protected against polarity reversal and short circuits
- Digital backlit display
- Pull-back fixing hook



8A



IP 65
Pb Wet, Gel Dry, Agm



Power supply voltage	220V-240V
Frequency	50-60 Hz
Rated current (Min-Max)	2-8 Amp
Battery voltage	12V
Battery capacity	5Ah-160Ah
Degree of protection	IP65
Battery type	Wet-Gel-Dry-AGM

Electronic multipurpose battery charger, 12-24V

- Backlit graphic display
- Charging and maintenance
- Protected against polarity reversal, short circuits
- 9 charging stages
- Floating system
- Battery recovery function
- Clamp holder
- Reclining fixing hook
- Supplied accessories: cable with clamp

16A



25A



Pb Wet, Gel Dry, Agm
LiFePO4 LITHIUM



1498/16A 014980126 ~~£ 661,00~~ **£ 284,00**

- Max. charging current: 16A, continuous
- SHOW ROOM function (13.8V - 12A)
- SUPPLY function (14V - 12A)
- Memory saving function (13.8V - 12A)

1498/25A 014980125 ~~£ 750,00~~ **£ 339,00**

- Maximum continuous charging current: 25A
- SHOW ROOM function (13.8V - 21A)
- SUPPLY function (14V - 21A)
- Memory saving function (13.8V - 21A)

1498/16A 1498/25A

	1498/16A	1498/25A
Power supply	220-240V	220-240V
Power	240W	390W
Charging current	4-16A	5-25A
Battery type	Agm - Wet - Lithium (LiFePo4)	Agm - Wet - Lithium (LiFePo4)
Charging capacity	5-360Ah	5-550Ah
Maintenance capacity	5-550Ah	5-800Ah
Output voltage	12-24V	12-24V
Minimum battery voltage	0,8V	0,8V
Protection degree	IP20	IP20
Dimensions	260x130x75 mm	260x130x75 mm

1760DGT 017600005 ~~£ 337,00~~ **£ 145,00**

Digital automotive multimeter

Technical Data:

- **RPM (tachometer):**
For 2 and 4 cylinder engines
RPM4 600 - 4000 RPM
RPM4 600 - 12000 RPM (x10 RPM)
RPM2/DIS 300 - 4000 RPM
RPM2/DIS 300 - 6000 RPM (x10 RPM)
- **Dwell angle:** 4-8 CYL
- **DC voltage:** 400mV-4/40/400/1000V
- **AC voltage:** 4/40/400/700V
- **DC current:** 40/400mA-4/20A
- **AC current:** 40/400mA-4/20A
- **Resistance:** 400Ω-4/40/400kΩ-4/40MΩ
- **Capacity:** 40/400nF-4/40/100μF
- **Frequency:** 5/50/500Hz-50/500-10MHz
- **Duty cycle:** 0.1 % - 99.9%
- **Pulse amplitude:** 1 - 10ms

- **Diode test:** Test current 0.3mA
- **Continuity:** <150Ω - Test current <0.3mA
- **Display:** High-contrast, backlit 4-digit LCD
- **Overvoltage:** Category II 1000V
- **Auto power off:** 30 minutes
- **Power supply:** 1 9V battery (included)
- Inductive clamp (included)
- 2 tips (included)
- Soft cloth case (included)
- Operating manual



195 mm
40 mm
92 mm



1497BS 014970190

~~£ 29,50~~ **£ 12,75**
Relay and fuse removal pliers, straight, thin pattern

The long, extremely thin noses allow the relay and fuse to be removed from small areas



L mm	L1 mm	A mm
230	45	14

1497SS 014970195

~~£ 27,00~~ **£ 12,00**
Self-locking pliers for soldering tinned wires

- Upper clips allow soldering wires to be clamped and brought close to each other.
- Built-in rack allows wires to be placed in 6 different positions



L mm	A Max mm
245	14÷70

1497/C23 014970200

~~£ 301,00~~ **£ 135,00**
Assortment of 23 tools for releasing electrical connectors

440x250x70 mm

1760/IR500 017600350

~~£ 229,50~~ **£ 99,00**
Digital infrared thermometer with dual laser aiming system
TECHNICAL DATA

Temperature range: $-50 \div 500 \text{ } ^\circ\text{C}$ ($-22 \div +932 \text{ } ^\circ\text{F}$)
 Display resolution: $0.1 \text{ } ^\circ\text{C}$ ($0,1 \text{ } ^\circ\text{F}$)
 Emissivity: $0.1 \div 1$ adjustable
 Accuracy: $-50 \text{ } ^\circ\text{C} \div +20 \text{ } ^\circ\text{C}$ ($\pm 3 \text{ } ^\circ\text{C}$);
 $20 \div 500 \text{ } ^\circ\text{C}$ ($\pm 2\%$ or $2 \text{ } ^\circ\text{C}$)
 Optical resolution (D:S): 12:1
 Auto power off: ca. 10 seconds
 Operating temperature: $0 \text{ } ^\circ\text{C} \div 50 \text{ } ^\circ\text{C}$
 Storage temperature: $-20 \text{ } ^\circ\text{C} \div 60 \text{ } ^\circ\text{C}$
 Power supply: 1 9V battery

1497/C94 014970300

~~£ 573,00~~ **£ 258,00**
Assortment of 94 car testing connectors
 For use with main diagnostic tools

Assortment contents:

- 2 t-taps
- 2 potentiometers
- 2 warning lights
- 2 SRS connectors
- 2 alligator clips
- 2 acicular probes
- 2 prods
- 2 dual banana connectors
- 4 single banana connectors
- 24 flat male terminals $0.6 \div 6 \text{ mm}$
- 12 round male terminals $1.6 \div 3.9 \text{ mm}$
- 24 flat female terminals $0.6 \div 6 \text{ mm}$
- 12 round female terminals $1.6 \div 3.9 \text{ mm}$



430x390x100 mm

1760PA/AC-DC2000 017600003
 £ 953,00 **£ 410,00**



Amperometric clamp with digital multimeter and data connection

MEASURABLE PARAMETERS:

- DC voltage: 0.1mV ÷ 1000V
- AC voltage: 0.1mV ÷ 1000V
- AC current: 0.01A ÷ 2000A
- DC current: 0.01A ÷ 2000A
- Resistance: 0.1Ω ÷ 60MΩ
- Capacity: 1nF ÷ 6000 μF
- Frequency: 10kHz ÷ 20kHz
- Temperature: -20 °C ÷ 1000 °C -4 °F ÷ 1832 °F
- Power supply: 3 1.5V batteries, type AA (included)
- Data connection (version 4.0)

2000A



300 mm
 45 mm
 110 mm



380x280x100 mm

1760PA/AC-DC 017600000
 £ 430,00 **£ 194,00**



Amperometric clamp and digital multimeter

SPECIFICATIONS

- DC voltage: 0.1mV ÷ 600V
- AC voltage: 0.1mV ÷ 600V
- AC current: 0.01A ÷ 1000A
- DC current: 0.01A ÷ 1000A
- Resistance: 0.1Ω ÷ 40MΩ
- Capacity: 0.001nF ÷ 40 μF
- Frequency: 0.001kHz ÷ 4kHz
- Temperature: -40°C ÷ 1000 °C -40°F ÷ 1832°F

1000A



1498BC/12 014980040 **£ 530,00 £ 228,00**

Multipurpose portable starter, 12V

- Device protecting against polarity reversal, short-circuit, overcurrent, overcharge and overheating

Supplied with:

- Protective case
- Cable with starting clamps
- USB ports for charging electronic devices
- LED battery charge indicator
- USB and USB-C cable
- Mains power supply
- Multifunction LED torch



40 mm
 100 mm
 225 mm



1500A

Starting current	600A
Pickup current	1500A
Battery type	4 cells LifePo4
Battery capacity	25000mAh

1498/12 014980480 **£ 883,00 £ 380,00**



Portable car starter, 12V

- Pickup current: 2200 A
- Sealed lead acid battery, solid electrolyte (AGM) type

1498/24 014980490 **£ 1.745,00 £ 750,00**



Portable car and commercial vehicle starter, 12-24V

- Pickup current: 4200 A (12V), 2100 A (24V)
- Sealed lead acid battery, solid electrolyte (AGM) type



Portable high-performance starter, ultralightweight

The microprocessor provides total protection against:

- polarity reversal
- short circuits
- incorrect voltage
- overloads
- underdischarge
- overcharge
- overtemperature



12V

12-24V



1498LT/12

014980012

£ 1.235,00

£ 530,00



- Weighs no more than 2.5 kg
- Cable length 500 mm
- Operating voltage 12V 1,3A



1498LT/12-24

014980014

£ 2.550,00

£ 1.100,00



- Up to 10,000A in 5 kg weight
- Cable length 160 cm
- Cable section 25mm²
- Automatic power supply 4 Amp



1498LT/12 1498LT/12-24

Operating voltage	12V	12/24V
Continuous amperage	800A	2000/1000 A
Maximum starting amperage	2000A	5000/2500 A
Peak amperage	4000A	10000/5000 A
Clamp amperage	1000 A	1000 A
Cable length	500 mm	1600 mm
Battery type	4 cells LifePo4	4 cells LifePo4
Memory saving function	Yes	Yes
Dimensions	260x135x72 mm	350x240x140 mm

1498TB/12-24

014980401

£ 937,00

£ 403,00

Digital battery tester, 12V, and starting/charging system analyzer, 12-24V

Allows the following to be tested: battery, alternator (smart and normal) and starter, diode ripple and chassis test

- fitted with software for printing test from PC
- compact, shockproof frame
- complete with input for connecting a removable mini printer (optional accessory, Beta 1498ST/TB)

Applications	- 12V battery test - Alternator charge test, 12-24V - Starter test
Operating range	100-2000 CCA
Reference standards	CCA, SAE, DIN, EN, IEC, JIS
Supported batteries	PB, WET, GEL, AGM, AGM FLAT, EFB
Voltmeter	9V-36V
Cable length	1600 mm
Languages	Italian, English, French, German, Spanish, Polish, Romanian, Dutch, Swedish and Finnish
Accessories included	USB cable and software



435x320x100 mm

960AD/TP2 009600510

~~£ 685,00~~ **£ 295,00**

1464T ✓

Set of adaptors for item 960TP in plastic case

Contents:

- Dummy injectors
- Dummy glow plugs
- Spark plug adaptors
- Oil cap adaptors
- Petrol injection couplers
- Set of spare gaskets

≡ 430x310x50 mm



1464APB 014640500

~~£ 579,00~~ **£ 249,00**

Set for testing high pressure system in FSI petrol engines, for use with item 1464T

Comes with 200 bar sensor and connectors

1464T ✓



≡ 240x210x50 mm

1464IC-RK 014640377

~~£ 248,00~~ **£ 107,00**

1464T ✓

Universal dummy injector kit for cars, trucks, marine engines and agricultural machines

Supplied with art. 1464IC



1464CBD 014640300

~~£ 998,00~~ **£ 447,00**

1464T ✓

Comprehensive adapter set for testing compression in petrol and diesel engines, with tester 1464T

Makes it possible to connect to engine to test petrol and diesel compression with tester 1464T

Contents:

- 8 dummy spark plugs with non-return valves
- 44 dummy glow plugs with non-return valves
- 1 adjustable universal dummy injector for cars, trucks, marine engines and agricultural machines
- 1 90° adapter, pressure release valve and connecting pipe
- Space accommodating tester 1464T in case

≡ 510x410x140 mm



1464T 014640050

~~£ 1.180,00~~ **£ 505,00**



Digital pressure and compression tester

- 5" touch screen display
- rechargeable polymer lithium battery
- complete with 80 bar sensor (for low pressure) and USB cable

1464AP 014640450

~~£ 1.016,00~~ **£ 459,00**

Set for testing high pressure system in common rail diesel engines, with item 1464T

- High pressure pipe set
- Fittings
- 2,000 bar sensor

1464T ✓



≡ 430x310x50 mm

1464FG 014640470

~~£ 442,00~~ **£ 190,00**

1464T ✓

Set of dummy regulators for testing diesel common rail system (for use with Beta 1464T-1464AP)

Used with the tester and suitable adapters, it makes it possible to determine whether the problem is the high pressure pump or the regulator when there is no pressure in the high pressure circuit in common rail engines.

Recommended for Bosch, Delphi, Denso and Siemens pressure regulators

≡ 350x250x80 mm



1464PT 014640550

~~£ 248,00~~ **£ 107,00**

Set for testing turbo pressure, for use with item 1464T

Comes with sensor and connecting cable



≡ 240x210x50 mm

1464T

1464TDI 014640600

~~£ 171,00~~ **£ 74,00**

Set for testing pump pressure in TDI engines, for use with item 1464T

Comes with connector

≡ 240x210x50 mm



1464T

1464FAP 014640610

~~£ 288,00~~ **£ 124,00**

Set for testing diesel particulate filter (DPF) pressure for item 1464T

Supplied with:

- 500 mbar sensor
- 8 mm adaptor with quick coupling and T fitting
- 3-m-long RJ45 cable

TECHNICAL DATA

- Vacuum test: 0÷500 mbar
- Resolution: 1 mbar

≡ 240x210x50 mm



1464T

1464ADB 014640620

~~£ 133,00~~ **£ 60,00**

Set for testing AdBlue® system pressure for item 1464T

Supplied with adaptors for use with 80-bar standard sensor supplied with item 1464T

≡ 240x210x50 mm



1464T



1464VD 014640570

~~£ 288,00~~ **£ 124,00**

Vacuum testing set for item 1464T

For measuring and storing maximum vacuum value

Supplied with:

- 800 mbar sensor
- 6 and 8 mm adaptors
- 3-m-long RJ45 cable

TECHNICAL DATA

- Vacuum test: 0÷800 mbar
- Resolution: 1 mbar



≡ 240x210x50 mm

1464T

1464PF 014640650

~~£ 1.037,00~~ **£ 446,00**

Set for testing pressure in braking system, for use with item 1464T

Comes with adapters and connectors

≡ 400x280x60 mm



1464T

1464PB 014640700

~~£ 772,00~~ **£ 349,00**

Set of 9 connectors for testing fuel low pressure (for use with item 1464T)

Quick connectors to tester 1464T allow fuel low pressure in diesel and petrol engines to be quickly checked

≡ 520x440x120 mm



1464T

1899SI

018990030

 £ 6.700,00 **£ 3.080,00**
2-in-1 machine for cleaning injectors and intake manifold

Special detergents can be used to periodically clean the injectors and the intake manifold in diesel and petrol engines, removing carbonaceous deposits and combustion residues

Specifications:

- Operating voltage: 12 V
- 2 service hoses with quick couplers
- 2 tanks (capacity: 1 l each)

11,6 kg

1899A/M

018990011

 £ 1.895,00 **£ 870,00**
DPF/FAP® system cleaning machine
Supplied with:

- 1 2-m-long feed pipe
- 1 quick coupler + hose nozzle for differential sensor hoses
- 1 niple M18x1.5 with hose nozzle for direct connection to lambda probe
- 1 extension hose
- 1 DPF/FAP® spray nozzle
- 1 magnetic pipe support
- 1 DPF/FAP® pipe with adjustment cable gland plus niple M14/16/18 mm for connecting lambda probes

Technical specifications:

- operating voltage: 12 V
- power supply cord length: 3.9 m
- tank capacity: 1 l



Special detergents can be used to periodically clean and restore DPF and FAP® systems damaged by soot and ash deposits. Results can be checked by self-diagnosis, which allows soot mass and differential pressure in diesel particulate filter before and after treatment to be determined.

Multi-purpose trolley

Can be used as a mobile workstation for diagnostic tools, laptops, testers and battery chargers

- Painted sheet metal frame: unparalleled firmness and sturdiness
- Ergonomic handle
- 2 fixed rear castors Ø 160 mm
- 2 steering front castors Ø 125 mm (one with brake)

CA49-G

049000112

 £ 1.046,00 **£ 473,00**

Multi-purpose trolley with door, empty
CX49-G

049000102

 £ 921,00 **£ 396,00**
Multi-purpose trolley, empty

2-level top

2 central shelves with adjustable position and 1 fixed low shelf



Pull-out drawer for housing a mini keyboard



1 paper holder



4 useful side cable reels made of plastic



2 useful side containers

CX49-G

CB52-0

052000201

~~£ 921,00~~ **£ 424,00**
400
Gearbox/transmission trolley with liquid recovery system

Inclined plane and drain holes allow liquids to be recovered in collection tank

Fitted with:

- 4 swivel castors, including 2 with brakes
- tool drawer
- pull-out liquid collection tank; capacity: 7 l
- 2 shelves

 870 mm
640 mm
1200 mm

CAPACITY 7 L
60 kg

Ø 100 mm

1877

018770008

~~£ 1.080,00~~ **£ 540,00**
Exhausted oil drain unit, wheeled, with 90 l tank

- Level indicator
- Big diameter pan with breakwater grate; capacity: 12 l
- Pneumatic tank emptying through 1.8 m pipe
- Tool tray

1877P

018770180

NEW!
~~£ 540,00~~ **£ 270,00**
Exhausted oil drain unit, wheeled, with polyethylene tank

- Tank capacity: 40 l
- Large oil pan made of PP
- Level indicator
- Pneumatic drum emptying



900 mm

1030±1630 mm

1877F

018770100

~~£ 129,00~~ **£ 64,50**
Exhausted oil drain unit for 1 l bottles

- Fits up to 4 bottles at a time
- Supplied with 2 2-l jerrycans

 405 mm
240 mm
270 mm

FITS UP TO 4 BOTTLES AT A TIME

1482SN

014820110

~~£ 72,50~~ **£ 33,00**
Quick coupler swivel pliers for fuel pipes, with articulated jaws

 L mm
260

1758RD 017580070

NEW!

~~£ 131,00~~ **£ 67,00**

Coolant funnel with quick couplings

Funnel capacity: 1600 ml with non-return valve, to avoid air bubble formation

Included accessories:

- 4 extension units for small spaces
- 4 quick couplings for coolant tank
- 3 rubber reduction units



1758S 017580080

NEW!

~~£ 98,00~~ **£ 50,00**

Wall-mounted support for funnels 1758 and quick couplings

Fitted with a drip tray, extremely convenient for replacing funnels and couplings after use



1758B-1,6 017580033

~~£ 51,00~~ **£ 22,00**

Non-return funnel, 1600 ml, with quick couplings

Quick couplings for VAG group vehicles



1758B 017580030

~~£ 51,00~~ **£ 23,00**

Non-return funnel with quick couplings

Particularly suitable for VAG cars



NON-RETURN



1758B-RNT 017580035

~~£ 37,00~~ **£ 16,00**

Non-return quick coupling for funnel item 1758B and 1758B-1,6

For Renault 1.5 dCi engine



Using these adapters with funnel 1758B allows oil to be effortlessly poured into any engines with reflux problems, without risking dirtying the engine compartment.

1758B/K5 017580040

~~£ 139,00~~ **£ 63,00**

Kit of non-return quick coupling adapters, for funnel 1758B and 1758B-1,6

Kit contents:

- 1 adapter for 1.5 dCi Renault, Dacia, Nissan engines
- 1 adapter for 1.5/1.6 dCi Renault, Dacia, Nissan engines
- 1 adapter for 3.0 BMW diesel engines
- 1 adapter for 1.5/2.0 petrol engines, VAG group
- 1 connecting adapter for funnel, with tap



1494T/C5 014940350

~~£ 97,50~~ **£ 44,00**

Set of special sockets for plastic oil drain plugs

Set contents:

- 1 socket for VAG group oil drain plugs
- 1 socket for BMW oil drain plugs
- 1 socket for PSA and Ford group oil drain plugs
- 1 socket for Mercedes oil drain plugs
- 1 "T"-handle wrench



17 mm

173x125x50 mm



1758ADB-D 017580050

~~£ 49,50~~ **£ 21,50**

Non-return funnel for AdBlue®, with straight coupling

1758ADB-45° 017580060

~~£ 55,00~~ **£ 25,00**

Non-return funnel for AdBlue®, with 45° coupling



MAXIMUM CAPACITY 1 L



1759HD/3 017590063

~~£ 748,00~~ **£ 322,00**

Cooling system seal testing and circuit filling tools

Make it possible to check circuit (pipes, joints, pumps, radiators) for leaks under pressure and quickly fill circuit, avoiding air bubble formation



600x500x140 mm

960KPC 009600780

~~£ 387,00~~ **£ 174,00**

Reversible impulse extractor with adjustable torque for glow plugs

- Pneumatic extractor with adjustable torque and special sockets allow jammed glow plugs to be unscrewed, thereby minimizing damage risk
- 5 1/4" impact sockets, long series, specially designed for glow plugs: 8-9-10-11-12 mm, 2 extensions and 1 articulated joint
- 4 adjustable driving torques: 10-20-30-40 Nm
- Right-hand and left-hand adjustment



420x185x60 mm

1759LR 017590070

~~£ 601,00~~ **£ 258,00**

Cooling system washing tool

Based on the use of compressed air, high water pressure allows for effective cleaning system washing

- Supplied with 6 system connection adapters
- Operating lever with position locking for continuous use
- Supplied with a water quick coupling



2,6 kg

390x330x100 mm



960KC-M8/M9/M10 009600801

~~£ 528,00~~ **£ 269,00**

Assortment of tools for removing broken or damaged glow plugs

FOR SPARK PLUGS WITH THREADS M8-M9-M10



380x290x50 mm

1949R 019490050

~~£ 97,50~~ **£ 42,00**

Blow gun for cleaning radiators

The 5 holes that are perpendicular to the handle allow dirt to be removed from radiators.



$\frac{\pm 0.5}{\text{mm}}$	L mm
6	600

960PI/K36 009600218

NEW!

1/4

~~£ 239,00~~ **£ 108,00**

Kit of brushes for cleaning injector seats

Kit contents:

- 12 nylon brushes, 8÷19 mm (1 mm interval)
- 12 steel brushes, 8÷19 mm (1 mm interval)
- 12 brass brushes, 8÷19 mm (1 mm interval)
- 1 bit holder with quick coupling and magnetic bottom
- 1 extension with quick coupling and magnetic bottom

960VTC 009600261

~~£ 382,00~~ **£ 172,00**

Leakage tester for petrol engine cylinders

After compressed air has been introduced into cylinder, gauge will allow it to be tested for compression leaks

Supplied couplers:
M10 - M12 - M14 - M14, long



2,3 kg

373x295x71 mm



1,2 kg

350x255x74 mm

1462/KI 014620235

~~£ 3.930,00~~ **£ 1.690,00**

Assortment of common rail diesel injector pullers

Allows DELPHI-BOSCH-SIEMENS-DENSO injectors to be removed

- Mechanical and hydraulic operation
- Includes one 12-t hydraulic jack
- Can be directly used on vehicle with mounted engine
- Numerous adjustment options on head make it possible to work on most engines available



530x470x140 mm

960ER 009600726 ~~£ 82,00~~ **£ 35,50**

**Slide hammer
for injector washers**



**STEPPED
DRILL BIT**

1454P 014540010 ~~£ 57,00~~ **£ 26,00**

**Scraper for removing
packing and sealant residues**

Particularly recommended for cleaning heads and flat surfaces to match



$\frac{S}{D}$ mm	L mm	L1 mm
3,3	210	32

1884 018840010 ~~£ 688,00~~ **£ 311,00**

**Oil filler tool for manual
and automatic gearboxes
and differentials**

Complete with 12 adaptors
for direct connection

- Fitted with nonreturn valve for leakage-free oil filling
- Delivery: 70 cc per pump shot
- Tank capacity: 7.5 l
- Maximum permissible oil viscosity: SAE 140



12 ADAPTORS		
FORD		AT-101
UNIVERSAL (Bmw, Honda, Nissan...)		AT-102
VW-AUDI		AT-103
VW-AUDI-PORSCHE		AT-104
VW-AUDI-MINI COOPER		AT-105
MERCEDES		AT-106
DSG		AT-107
VW-AUDI CVT		AT-108
VOLVO		AT-109
TOYOTA-LEXUS		AT-110
SKODA		AT-111
VW Passat/Tiguan <2007		AT-112

1884N/C8 018840200

~~£ 169,00~~ **£ 73,00**

Set of 8 adaptors for item 1884

Set contents:

- 1 adapter for Infiniti, 7-speed, M8x1.0
- 1 adapter for Honda, Hyundai, Kia 5x8x200 mm
- 1 adapter for Skoda M18x1.5
- 1 adapter for Mini M14x1.5
- 1 adapter for Nissan M10x1.5
- 1 adapter for Nissan Juke M12x1.25
- 1 adapter for GM M12x1.75
- 1 adapter for VAG group vehicles, 7-gear



≡ 200x145x40 mm

1438K/DSG-2 014380260

~~£ 873,00~~ **£ 375,00**

**Tool set for aligning 6- and 7-speed
DSG clutches**

For use with 6-speed DSG
and manual-shift, 7-speed DSG
(series 1 and 2) and S-tronic gearboxes.



≡ 350x370x117 mm

1438K/PWR 014380270

~~£ 600,00~~ **£ 258,00**

**Removal/installation tool set for
Powershift dual clutch transmission**



≡ 440x400x85 mm

1471M/C22 014710101

~~£ 328,00~~ **£ 141,00**

Pneumatic tool for pushing back and rotating right and left disc brake pistons with accessories

- Automatic jack
- Thrust: 150 kg
- Operating pressure 5÷8 bar



350x310x85 mm

1466/C5 014660100

~~£ 178,00~~ **£ 81,00**

Kit of 5 brake bleeding wrenches

Kit contents:

- 5 wrenches sizes 7-8-9-10-11 mm
- 1 drain hose with check valve



OIL GOES INTO BUSH

260x170x50 mm

1467LF/2 014670099

~~£ 2.470,00~~ **£ 1.140,00**



Electric instrument for brake fluid replacement
Allows brake fluid to be easily and quickly replaced on vehicle

- Automatically stops when tank is empty, thereby preventing air from being let in
- Maximum tank volume: 20 l
- Operating pressure: 0.4÷3.5 bar
- Power supply: 230V

Supplied with:

- Brake oil recovery tank
- 1 standard cap E20

“PULSATING EFFECT”

15 kg



1471T/C5 014710400

~~£ 356,00~~ **£ 153,00**



5 slogging wrenches for truck brake calipers

Can be used with torque wrenches for tightening operations

Included sizes:

- female Torx wrenches E18, E20, E24
- ring wrenches M24, M26



275x220x60 mm

Tyre inflator

- Shockproof rubber coated body
- Metal operating lever
- Operating pressure: 0,5÷12 bar, 7÷174 psi
- Pipe length: 58 cm
- 360° hose rotation
- 1/4" air inlet



DIGITAL



1949DGT/2 019490021

~~£ 174,50~~ **£ 75,00**

Digital tyre inflator

- 4 units of measurement, bar/psi/kpa/kgf
- Backlit LCD display
- Resolution: 0.05 bar
- Self-power off after 1.5 minutes

1949GPA 019490018

~~£ 144,50~~ **£ 62,00**

- Pressure release feature
- Pressure measurement feature

1713M/K7

017130100

~~£ 181,50~~ **£ 93,00**
Kit of 7 inspection tools

Kit contents:

- 1 telescopic handle, length 185÷660 mm and 1/4" hexagon drive
- 1 rectangular inspection mirror, 65x43 mm
- 1 round inspection mirror, Ø 52 mm
- 1 magnet, Ø 16.3 mm
- 1 ultra-bright LED light
- 1 flexible pickup tool (item 1713M)
- 1 magnetic tote tray made from stainless steel
- 3 LR44 cell batteries

NEW!
1/4"
**LENGTH
185÷660 mm**

297x165x52 mm

1950BZK

019500078

~~£ 421,00~~ **£ 190,00**
Tyre bead seater

- Secondary handle with push-button operation helps keep hold of tool during use
- Tank capacity: 18 l
- Operating pressure: 3-8 bar
- Maximum tank pressure: 16 bar
- Pressure relief valve
- Gauge with graduated scale
- Plastic inlet preventing rim damage

**TANK CAPACITY
18 L**

 660 mm
290 mm
440 mm

5,3 kg

972/C10

009720010

~~£ 413,00~~ **£ 178,00**
Removal kit for damaged wheel nuts

For use on anti-theft and conventional nuts



290x250x60 mm

972/C4BMW

009720004

~~£ 328,00~~ **£ 141,00**
Removal kit for anti-theft bolts with free rings, for BMW and Mini cars

516x145x66 mm

983PM 009830010 ~~£ 105,50~~ **£ 48,00**

Abrasive brush for cleaning hubs



Ø1 mm	Ø2 mm
90	150

983 PM/R-DA 009830050

~~£ 90,50~~ **£ 41,00**

Abrasive discs, pair, for item 983PM

Ø
150 mm



720FRD 007200633 ~~£ 28,50~~ **£ 12,50**

Impact socket for Ford wheel nuts with aluminium damaged caps



Required when nut caps are damaged by impact wrenches



mm	L mm
18,5÷19,5	63

1566R 015660015 ~~£ 37,00~~ **£ 16,00**

Adjustable tool for removing/installing steering arms



Ø mm
27÷43

1471PT/C5 014710367 ~~£ 104,00~~ **£ 47,00**

Impact socket kit for brake calipers nuts

For cars of Volkswagen, Audi & Porsche group
 • 3 10-tooth sockets: 11.5 mm - 15 mm - 20 mm
 • 2 7-tooth socket: Ø 14 mm - 22 mm



7-tooth 10-tooth



Ø mm	L mm
25	50

720RNG 007200634 **NEW!** ~~£ 24,00~~ **£ 12,00**

Impact socket for Jeep Renegade wheel nuts with aluminium damaged caps

Required when nut caps are damaged by impact wrenches



mm	L mm
16,5÷17,5	63

1568 015680001 **CE** ~~£ 322,00~~ **£ 138,00**

Pneumatic assembly tool for silicone axle shaft boots

- 8 spreader arms
- Maximum arm spreading: 145 mm



L mm	L1 mm
420	195

1567

015670001

~~£ 471,00~~ **£ 203,00**
Lever for removing wishbone heads and shock absorbers from pillar

One operator can position lever effortlessly and proceed with disassembly

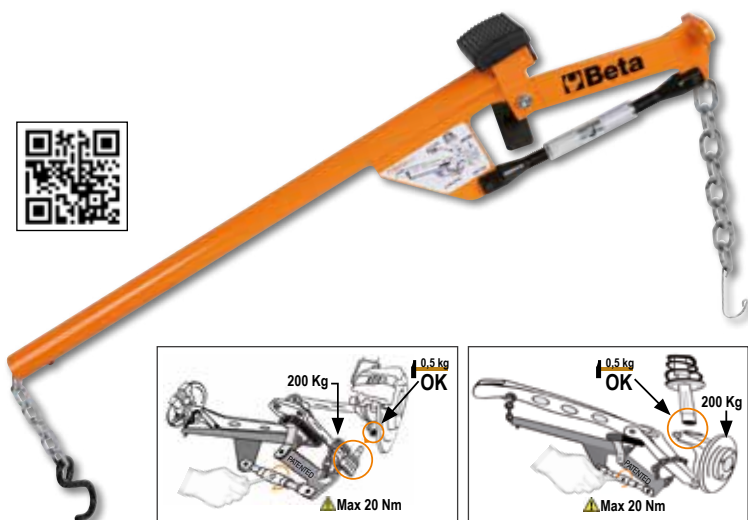
1569/SB

015690016

~~£ 388,00~~ **£ 145,00**
Assortment of tools for removing and installing rear axle silent blocks, riving shaft oil seals and wheel bearings

Bushings can be used both on vehicle and on hydraulic press

13 kg

425x365x100 mm

1550U

015500010

~~£ 4.260,00~~ **£ 1.830,00**
Pneumatic shock absorber removal tool for cars, SUVs and commercial vehicles

- Upper universal hold system that allows all left/right-hand spring diameters to be compressed with one upper adaptable plate
- Active safety system on spring: safety hook and 3 locking valves allow spring to be properly positioned/seated, maintaining such position throughout compression. If spring is not positioned properly, system will stop machine.
- Protective "Full Body" Grille

- Supplied with 2 lower forks for diameters 78-205 mm
- Maximum thrust: 2 tons (10 bars) - 1.6 tons (8 bars) - 1.2 tons (6 bars)
- Spring compression stroke: 335 mm

MAXIMUM THRUST 2 TONS (10 BAR)

 1670 mm
 610 mm
 825 mm

1550U/SS187

015500018

~~£ 538,00~~ **£ 231,00**
Left-hand fork for item 1550U

Particularly suitable for left-hand springs, e.g. Nissan Qashqai and Renault Koleos

1550U/M

015500021

~~£ 491,00~~ **£ 211,00**
Vice for shock absorber removal tool item 1550U

Allows shock absorber stem to be locked



1366SH 013660400 ~~£ 2.690,00~~ **£ 1.160,00**

NEW!

Multifunction bodywork spotter

- Microprocessor for managing welding parameters
- Contact and manual welding cycle start
- Automatic spot welding time setting function
- Supplied with quick coupling gun and 2.2-m-long ground cable

Accessory kit contents:

- extractor hammer
- three-pointed washer head
- 10 three-pointed washers
- carbon electrode
- squashing electrode

Power supply	230V
50% power	2.5 KVA
Power peak	13 KVA
Amp output	2850 (2%) A
Max. Amp output	3200 A



23 kg

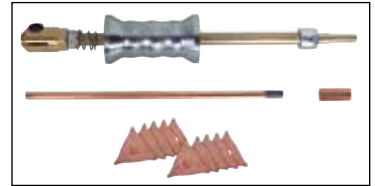

1366SH/C 013660410

NEW!

~~£ 491,00~~ **£ 222,00**

Trolley for spotter 1366SH



1365/K13 013650013 ~~£ 992,00~~ **£ 509,00**

Oil pressure pump, 10 t, and bodywork accessories kit in handy trolley

Kit contents:

- oil pressure pump, 10 t, with 1.5-m-long hose, 1/2" coupling
- piston
- wing opening pliers; capacity: 500 kg
- baseplate, 150x90 mm
- L-shaped base, 50x50 mm
- 4-point punch
- round, knurled punch, Ø 50 mm
- wedge-shaped punch, 43 mm
- 240-mm-long extension
- 450-mm-long extension
- 475-mm-long extension
- rubber head
- male-to-male coupling for installing accessories



33 kg

900x420x180 mm

1361/K9 013610030 ~~£ 395,00~~ **£ 179,00**

Kit of 8 levers for bodywork dent pullers

Kit contents:

- round ball head rod, Ø 31 mm, length 110 cm
- tip rod, length 62 cm
- whale tail tip rod, length 112 cm
- hook tip rod, length 27 cm
- flat round head rod, length 50 cm
- round ball head rod, Ø 19 mm, length 52 cm
- whale tail head rod, length 27 cm
- round whale tail head rod, length, 28 cm
- fabric bag with handles

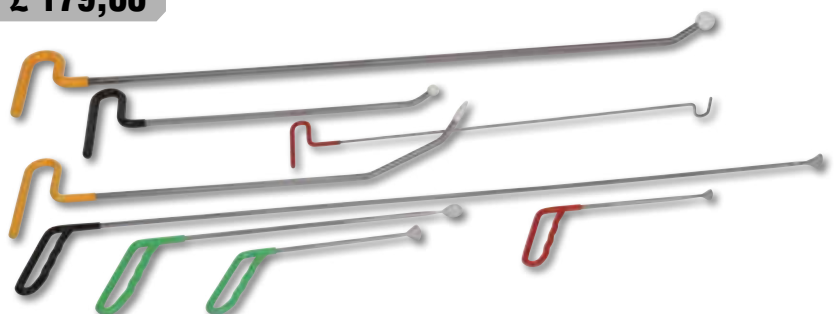

1366A 013660200 ~~£ 111,50~~ **£ 50,00**

Dent puller with kit of 19 plastic glue tabs

Ideal for removing:

- Hail dents
- Dents caused by doors
- Small dents in general



1367/K4 013670010 **NEW!**

~~£ 77,00~~ **£ 39,50**

Kit of 4 wheel arch clamps, arc-type

Particularly suitable for aligning wheel arch with door

- Maximum jaw opening: 6.5 mm



1479L/K4 014790604 ~~£ 47,00~~ **£ 21,00**

4 wrecking bars for jobs on dashboards and delicate parts



1479LB/C5 014790150

~~£ 153,00~~ **£ 69,00**

Kit of 5 metal trim pin removers



215x165x50 mm

1478/K3 014780160 ~~£ 138,50~~ **£ 63,00**

Pin removing pliers kit with plastic clips assortment

Kit contents:

- Flat nose pliers (1 pc.)
- 90° bent nose pliers (1 pc.)
- 625 plastic clips in 16 different sizes
- Clips in 3 stackable PPL containers

L mm	L1 mm
180	170

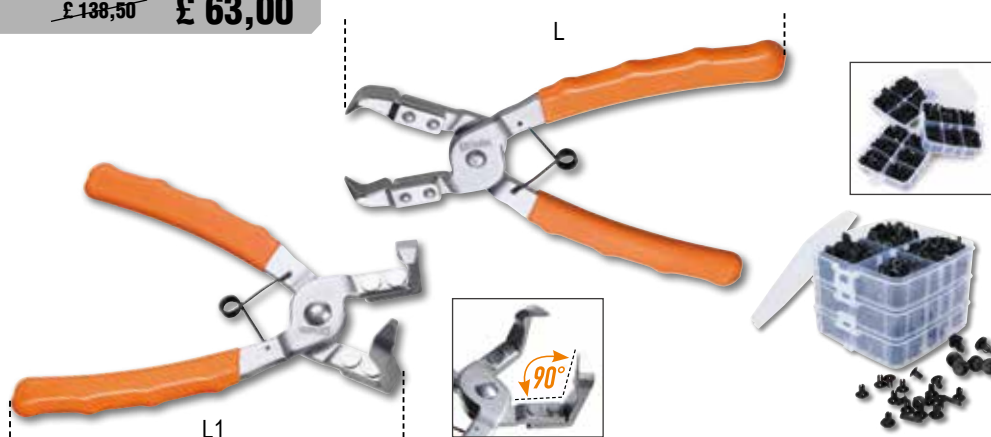

1478NSS 014780163 ~~£ 58,00~~ **£ 25,00**

Plastic pin removal pliers with 3 release points



L mm
180

1364SE 013640001

~~£ 549,00~~ **£ 248,00**

Extension bodywork support

Specifications:

- 4 swivel castors, 2 with brakes
- Pantograph can be extended up to 1400 mm
- Vertically adjustable up to 1315 mm
- Position locking
- Contact surface covered with removable rubber

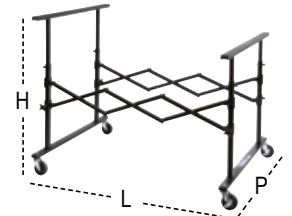

L mm	H mm	P mm
215÷1400	780÷1315	890

1364SV 013640002

~~£ 323,00~~ **£ 146,00**

Bodywork support with central tray

Specifications:

- Contact surface covered in polyethylene
- Tray dimensions: 340x845x40 mm
- Foldable



H mm
1000

1364SCP 013640003

~~£ 519,00~~ **£ 234,00**

Revolving bodywork support

Specifications:

- Particularly suitable for bonnets, wings and doors
- Fitted with 4 castors - 2 steering with brakes
- Can be rotated up to 180°

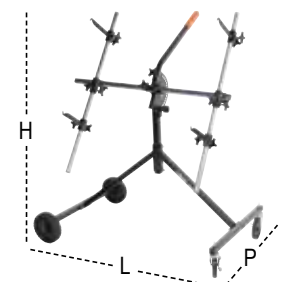

L mm	H mm	P mm
1100	1300	680

1364SP 013640004

~~£ 260,00~~ **£ 118,00**
Bodywork support with suction cups

Specifications:

- Particularly suitable for use with windows
- Fitted with 4 suction cups, Ø 95 mm
- Extension can be adjusted by means of a chain
- Polyethylene coated tube

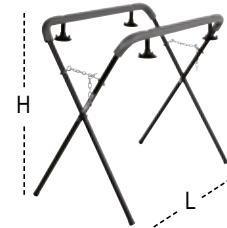
PARTICULARLY SUITABLE FOR USE WITH WINDOWS

L mm	H mm
950	1250

1364SR 013640005

~~£ 316,00~~ **£ 143,00**
Wheeled dispenser for masking paper rolls

Specifications:

- With 2 handling wheels
- 3 paper roll bars with built-in paper cutting blade
- Built-in paper tape support
- Max. paper roll dimensions: 350 - 650 - 1050 mm

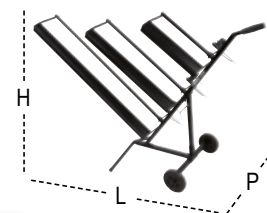
NEW!

L mm	H mm	P mm
1530	1080	520

1768 017680010

~~£ 242,50~~ **£ 109,00**
Aluminium footboard
200

SURFACE COATED WITH NON-SLIP MATERIAL

L mm	L1 mm	H mm
960	300	475

3009 030090001

~~£ 565,00~~ **£ 243,00**
Wheel lifter

Maximum lifting capacity: 550 kg

- 4 pivoting rollers
- Roller width: 200 mm
- For wheels up to 240 mm in width

550

IDEAL FOR:

- **LOADING DAMAGED CARS ONTO TOW TRUCKS**
- **CAR REPAIR GARAGES**
- **MOVING CARS IN SHOWROOMS**

2254A

Car covers, for outdoor use, water-repellent and UV-resistant

Technical specifications:

- Exterior finish with UV protection treatment
- Soft, nonscratch interior finish
- 6 adjustment strings for making cover fit close to car
- 2 front door zips to allow access to vehicle without having to remove cover
- Mirror seats
- Reflecting



	Tg	Categories	Dimensions mm		£
2254A/M	M	COMPACT CARS	4000X1450X1300	022540002	£ 206,50 £ 89,00
2254A/L	L	SALOON CARS AND STATION WAGONS	5300X1450X1150	022540000	£ 231,00 £ 99,00
2254A/XL	XL	SUV	4700X1450X1580	022540001	£ 210,50 £ 91,00

THESE COVERS ARE IDEAL FOR PROTECTING DAMAGED VEHICLES WHILE WAITING TO BE REPAIRED

2254K

022540101

~~£ 40,00~~ **£ 18,00**

Reusable seat, steering wheel and gear knob protector



3099E

Outdoor motorcycle cover, water and dust resistant

Protects paint from scratches, dust and sunlight.

- Size "M" recommended for sports and naked motorcycles and mid-size scooters
- Size "L" recommended for maxi enduro and crossover motorcycles

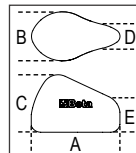

	Tg	A mm	B mm	C mm	D mm	E mm		£
3099E/M	M	2290	990	1250	350	900	030990102	£ 111,00 £ 50,00
3099E/L	L	2500	1100	1650	1100	1500	030990103	£ 137,00 £ 59,00

3099T

Indoor motorcycle cover, made from stretch fabric

Protects paint from scratches, dust and sunlight.

- Size "M" recommended for sports and naked motorcycles and mid-size scooters
- Size "L" recommended for maxi enduro and crossover motorcycles
- Size "XL" recommended for super touring motorcycles

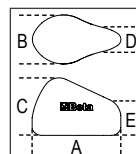

	Tg	A mm	B mm	C mm	D mm	E mm		£
3099T/M	M	2050	900	1000	350	800	030990202	£ 97,00 £ 41,50
3099T/L	L	2700	1100	1300	550	1100	030990203	£ 118,50 £ 51,00
3099T/XL	XL	3100	1300	1400	700	1200	030990204	£ 143,00 £ 61,00

1875LT 018750000

~~£ 663,00~~ **£ 335,00**

**Injection/extraction
carpet/upholstery cleaner**
Ideal for deeply cleaning textile surfaces.

It dispenses pressure sprayed detergent and sucks it up with dirt, leaving surfaces almost dry

Supplied accessories:

- 1 hose complete with ergonomic handle
- 1 dispenser unit
- 2 hard extensions
- 1 small spray extraction nozzle
- 1 big spray extraction nozzle
- 6 power cord locknuts

Technical data:

- voltage: 230/240 V
- frequency: 50/60 Hz
- max. power: 1100 W
- airflow rate: 58 l/sec.
- max. drum capacity: 20 l
- max. detergent tank capacity: 3 l
- max. pump pressure: 7 bar
- max. suction pressure: 21 kPa
- pump power: 48 W

**HIGHLY EFFECTIVE FOR
CAR SEATS AND INTERIORS**

1875SP/K3 018750010

~~£ 21,40~~ **£ 11,00**

Kit of fabric cleaning brushes

- 1 flat brush Ø 48 mm
- 1 flat brush Ø 100 mm
- 1 hemispheric brush Ø 90 mm
- 1/4 impact socket drive"

1898/S 018980932

~~£ 35,50~~ **£ 16,00**
**Hand pressure pump
with 5 l tank**

- Stainless steel nozzle
- Locking lever for continuous jet
- Adjustable nozzle with straight jet and mist spray
- Shoulder strap for ease of transport
- Nozzle hook-up handle
- 1.2-m-long hose
- Not for use with hydrocarbons

1898/M 018980930

~~£ 20,50~~ **£ 8,80**
**Pressure sprayer
with 2 l tank**

- Adjustable nozzle with straight jet and mist spray
- Graduated scale (0.5 l - 1 l - 1.5 l - 2 l)
- Locking lever for continuous jet
- Not for use with hydrocarbons

2 l

3003PRO 030030150 ~~£ 484,00~~ **£ 208,00**

Creepers made of shockproof plastic

- Ergonomic head cushion
- Soft back protector
- 2 178 mm double bearing castors for trouble-free use on uneven surfaces and pipes/cables
- 1 steering castor
- Double height adjustment from the ground: 38 or 76 mm
- 2 portable LED lamps (250 lumens) with fixing magnets
- Load capacity: 200 kg
- Weight: 7.7 kg



DOUBLE LED LAMP WITH MAGNET

DURABLE AND ERGONOMIC

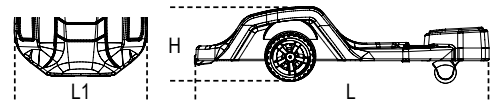

H min mm	H Max mm	L mm	L1 mm
170	230	1040	570

3002 030020001 ~~£ 140,50~~ **£ 63,00**

Creepers and seat

- Steel frame
- PVC lining with upholstery
- Easily convertible into a creeper or a seat

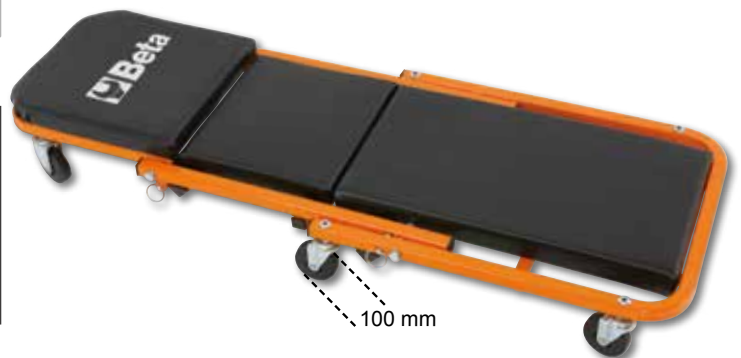

3029L/2T 030290120 ~~£ 635,00~~ **£ 273,00**

Long, lowered hydraulic jack, 2 t

Makes it possible to work on vehicles with a reduced height from the ground and internal lifting point

- Controlled descent speed
- Quick approach pedal
- Nylon wheels

H min-Max mm	L mm	L1 mm
75÷530	930	295



3029/2T 030290020 ~~£ 561,00~~ **£ 241,00**

Lowered hydraulic jack, 2 t, with 4 wheels

- Quick approach pedal
- Steel frame and nylon wheels
- Minimum height: 75 mm

H min-Max mm	L mm	L1 mm
75÷500	720	290



3033E/3T 030330130

~~£ 586,00~~ **£ 252,00**
Hydraulic jack, 3 t

- Controlled descent speed
- Nylon wheels

H min-Max mm	L mm	L1 mm
95÷515	700	370

3030H/2T 030300220

~~£ 986,00~~ **£ 424,00**
High-lift hydraulic jack, 2 t, with 6 wheels

Makes it possible to work on vehicles that are high from the ground and have a long shock absorber travel

- Controlled descent speed
- Quick approach pedal
- Nylon wheels

H min-Max mm	L mm	L1 mm
85÷780	1010	300

3030/2T 030300020

~~£ 1.045,00~~ **£ 449,00**
Lowered hydraulic car jack, 2 t with 6 wheels

- Car jack can be easily handled on uneven, irregular floors
- Dual front tilting wheels made of plastic material (PTFE)
- Pedal allows easy approach

H min-Max mm	L mm	L1 mm
85÷520	860	400

3033/3T 030330030

~~£ 1.640,00~~ **£ 705,00**
Hydraulic jack, 3 t long version

- Particularly suitable for use on commercial vehicles
- Polyamide wheels

H min-Max mm	L mm	L1 mm
140÷520	1180	370



3028

Hydraulic press with moving piston



20 t

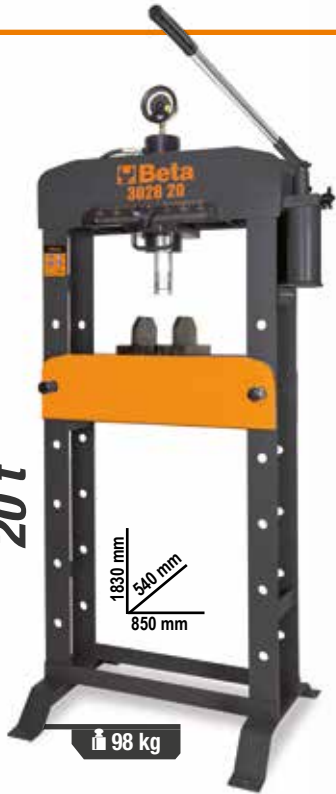

1830 mm
540 mm
850 mm

98 kg

3028 20 030280020

£ 2.660,00 £ 1.140,00

30 t



1850 mm
540 mm
850 mm

132 kg

3028 30 030280030

£ 3.230,00 £ 1.390,00

50 t



1850 mm
650 mm
1100 mm

241 kg

3028 50 030280050

£ 4.970,00 £ 2.140,00

15 t



850 mm
490 mm
678 mm

57 kg

NEW!

3028 15 030280015

£ 1.320,00 £ 675,00

3028 15 3028 20 3028 30 3028 50

Maximum capacity	15 t	20 t	30 t	50 t
Single speed pump	✓	✓	✓	✓
Moving piston	✓	✓	✓	✓
Hydraulic safety in case of overloading	✓	✓	✓	✓
Gauge	✓	✓	✓	✓
Set of V-shaped prisms	✓	✓	✓	✓
Hoist	X	X	X	✓

3028SP

Protective screen for presses 3028



3028/KP 030280055

NEW!

£ 182,00 £ 82,00

Kit of pin punches and plate for presses 3028

Sizes of pin punches:

- Ø10X90mm
- Ø12X90mm
- Ø16X90mm
- Ø18X115mm
- Ø20X115mm
- Ø22X115mm
- Ø25X140mm
- Ø30X140mm



NEW!

	Presses		£
3028SP/15	3028 15	030280016	£ 191,00 £ 86,00
3028SP/20	3028 20	030280021	£ 214,00 £ 97,00
3028SP/30	3028 30	030280031	£ 214,00 £ 97,00
3028SP/50	3028 50	030280051	£ 226,50 £ 102,00

3023 030230050

~~£ 283,00~~ **£ 141,50**

Pit and under bridge jack with screw adjustment



350 kg



H min-Max mm	Ø mm
1350÷2030	300

3025N 1,0 030250110 ~~£ 2.870,00~~ **£ 1.320,00** **NEW!**

Folding hydraulic crane with dual effect pump

- Maximum capacity: 1 t
- 4 loading positions: 300-600-800-1000 kg
- With load limiting valve and chrome-plated stand
- Controlled descent speed
- Nylon wheels
- Maximum height: 2420 mm



1000÷1300

1 t

1560 mm
1000 mm
1600 mm

99 kg

CE

3011T

Hydraulic bottle jacks



3010T

Jack stands, pair



NEW!	C max kg	H min+max mm		£	£
3011T 2	2000	170÷366	030110020	£ 104,50	£ 50,00
3011T 3,5	3000	170÷366	030110035	£ 122,50	£ 56,00
3011T 5	6000	203÷467	030110050	£ 135,00	£ 61,00
3011T 10	10000	220÷484	030110100	£ 208,50	£ 95,00
3011T 15	15000	230÷497	030110150	£ 263,00	£ 119,00
3011T 20	20000	245÷521	030110200	£ 398,00	£ 163,00

	C max kg	H min+max mm		£	£
3010T 2	2000	280÷425	030100002	£ 135,50	£ 58,00
3010T 3	3000	285÷430	030100003	£ 163,00	£ 70,00
3010T 6	6000	400÷580	030100006	£ 254,00	£ 109,00
3010T 10	10000	471÷735	030100010	£ 387,00	£ 199,00

3050/600

Electro-hydraulic motorcycle jack, 600 kg

- Electrical, mechanical and hydraulic safety devices
- Capacity: 600 kg
- Integrated electro-hydraulic unit: 230V - 50 Hz
- Hydraulic pump
- Controlled downward speed
- Safety fuses for protection in case of cable cuts
- Control push button panel
- CE-certified, TÜV-approved



600 kg

H Max

H Min

198 kg

CE

Ral 2011	Ral 7016	Ral 3000
030500201	030500202	030500203
£ 7.490,00	£ 3.745,00	

H min-Max mm	L mm
185÷1110	2100

8143

Hand chain blocks

- Professional model, made of first-rate materials
- Automatic brake with double pawl system with double pawl system
- Swivel hook with safety latch

TÜV EN13157



8146

Lever hoists

- Professional model, complies with EN13157 standard, easy to install and use.
- Automatic brake with double pawl system for optimized safety.
- Swivel hook with safety latch.

TÜV EN13157



USER-FRIENDLY, SAFE

8143 0,5T

081430005

£ 206,50 £ 93,00

WLL t	L m	kg
0,50	3	9,2

8146C 0,25T

081460002

£ 233,00 £ 105,00

WLL t	L m	kg
0,25	1,5	2,5

8143 1T

081430010

£ 245,00 £ 110,00

WLL t	L m	kg
1	3	11,7

8146 0,75T

081460008

£ 239,50 £ 108,00

WLL t	L m	kg
0,75	1,5	6,7

8143 2T

081430020

£ 355,00 £ 161,00

WLL t	L m	kg
2	3	19,5

8146 1,5T

081460015

£ 351,00 £ 159,00

WLL t	L m	kg
1,50	1,5	11,2

8135

Steel plate lifting clamps with articulated lifting eyes

- Professional model, compliant with EN13155, made from high-quality materials
- Suitable for lifting steel plates, rotating by 180°, and plate transportation in vertical position
- For plates with hardness up to 30HRC (300HB)
- Cam safety lock for easier steel sheet insertion and safe gripping
- Identification plate with serial number and batch number
- Safety factor: 3:1
- Minimum WLL is 10% of maximum WLL



TECHNICAL DATA

- Safety factor: 3
 - Serial number identification plate
- AVAILABLE CERTIFICATES
- Manufacturer's Certificate
 - CE Declaration of Conformity
 - Test report UNI EN10204 type 2.2
 - Technical product specifications



Do not lift any load weighing less than 10% of the maximum rated capacity.

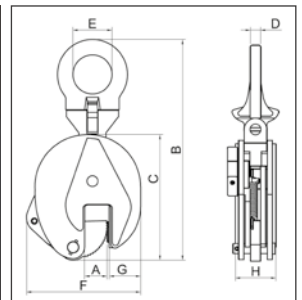

	max WLL t	A mm	kg		£
8135 0,75T	0,75	0-15	2	081350005	£ 152,00 £ 65,00
8135 1,0T	1,0	0-20	5	081350010	£ 199,50 £ 86,00
8135 2,0T	2,0	0-25	8	081350020	£ 281,00 £ 121,00

max WLL (t)	Dimensions mm						
	B	C	D	E	F	G	H
0,75	205	125	10	27	105	35	40
1,0	290	170	12	48	145	45	56
2,0	375	205	17	67	175	56	56

ROBUR's permanent magnetic lifters stand out as compact, sturdy, reliable machines; they are widely used in factories, warehouses, harbour quays and transportation facilities. Designed in compliance with EN13155, this equipment is suitable for lifting and handling magnetic iron materials, including dies, sheet metal, pipes, fittings, beams and bars.

The permanent magnet is made from a Neodymium-Iron-Boron alloy, which has an extremely high attractive force and is defined as "super magnetic".

Since magnetic lifters require no voltage, they can also be used in places where no power connection is available. One operator can easily lift, transport and release the load through the operating lever: when the lever is moved into the ON position, a spring mechanism will lock it, keeping the magnet active and preventing accidental release.



8134

NEW!

Permanent magnetic lifters

TECHNICAL DATA

- Safety factor: 3
- Identification tag

AVAILABLE CERTIFICATES

- Manufacturer's Certificate
- Declaration of Conformity with Machinery Directive 2006/42/EC
- Test Report UNI EN10204 type 2.2
- Operation and maintenance manual

CE EN13155

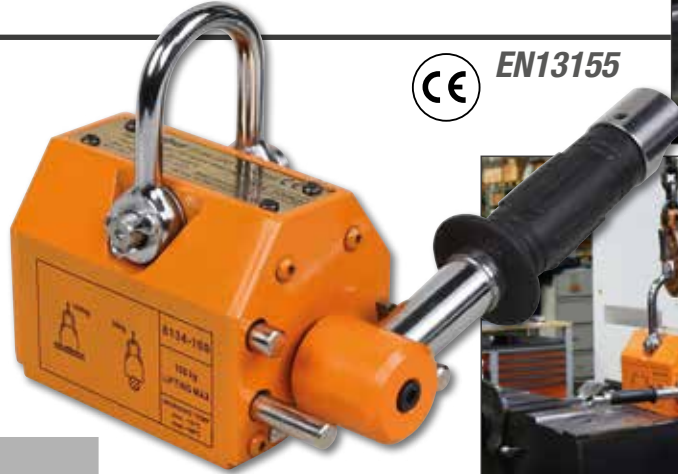

		£	£
8134 100 KG	081340010	£ 540,00	£ 232,00
8134 300 KG	081340030	£ 950,00	£ 409,00
8134 600 KG	081340060	£ 1.770,00	£ 760,00
8134 1000 KG	081340100	£ 2.920,00	£ 1.260,00

Remove any protective films, dirt, grease, oil etc. between the magnet and the load.

Automatic hose reel

Shockproof plastic body, for air or water

- Netted polyurethane hose
- Device for automatic locking of the hose at required length
- Rack mechanism can be disabled to keep hose in traction
- Operating temperature range: -5 °C / +50 °C
- Supplied with a 180° swivel bracket and an additional quick connection bracket

1900S 8X10 019000080

~~£ 231,50~~ **£ 100,00**

CE

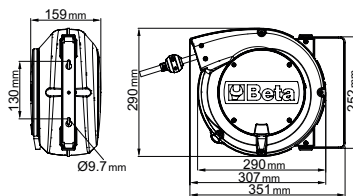

Air inlet	GAS	1/4"
Hose length	m	10
Operating pressure	bar	15
Ø Hose	mm	8x12
Hose material		polyurethane



1900M 10X15 019000115

~~£ 323,00~~ **£ 146,00**

CE

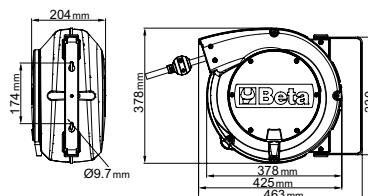

Air inlet	GAS	3/8"
Hose length	m	15
Operating pressure	bar	15
Ø Hose	mm	10x14
Hose material		polyurethane



720XZN/C6

007201530

NEW!

12" ○

~~£ 139,00~~ **£ 71,00****Set of 6 impact socket drivers for XZN® head screws, phosphated, in metal case**

M8-M10-M12-M14-M16-M18



≡ 275x120x65 mm

720B/C12

007201912

NEW!

12" ○

~~£ 221,50~~ **£ 95,00****Set of 12 bi-hex impact sockets, phosphated, in metal case**

○ 10-11-12-13-14-17-19-22-24-27-30-32 mm



≡ 195x80x55 mm

720ME/C8

007200525

12" ○

~~£ 175,00~~ **£ 79,00****Set of 8 impact socket drivers for hexagon screws**

○ 5-6-8-10-12-14-17-19 mm



≡ 270x120x45 mm

720LC/C3

007200653

12" ○

~~£ 44,00~~ **£ 20,00****Set of 3 impact sockets for wheel nuts, with polymeric inserts, in plastic case**

○ 17-19-21 mm



≡ 148x132x44 mm

1927XM

019270030

~~£ 388,00~~ **£ 163,00**

12" ○

Compact reversible impact wrench

- Single hammer impulse device
- Amazingly compact and powerful
- One-hand reverse button
- Three power adjustable screwing positions
- Exhaust through handle
- Balancing hook



≡ 1,3 kg

Free speed	rpm	10.000
Impulse device		Single hammer
Max. torque	Nm	770
Bolt capacity	Cl 8.8	M22●34 mm
Bolt capacity	Cl 12.9	M18●27 mm
Air inlet	GAS	1/4"
Operating pressure	bar	6,2
Internal hose size (Ø)	mm	10
Mean air consumption	l/min	122

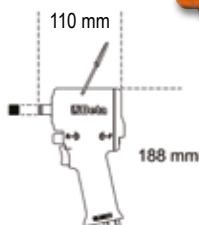
**1927XM/K5**

019270129

12" ○

~~£ 455,00~~ **£ 196,00****Assortment of 1 compact reversible impact wrench and 5 impact sockets, in plastic case**

○ 720 17-19-21-22-24 mm

≡ 2,8 kg

≡ 307x206x86 mm

1927CD 019270007

~~£ 508,00~~ **£ 218,00**
12"
Reversible impact wrench

- Double hammer impulse device
- Lightweight and well-balanced for enhanced ease of use
- High torque
- Reversible lever
- Three power adjustable screwing positions
- Exhaust through handle
- Silenced

Free speed	rpm	7.000
Impulse device		Double hammer
Max. torque	Nm	1020
Bolt capacity	Cl 8.8	M22●34 mm
Bolt capacity	Cl 12.9	M18●27 mm
Air inlet	GAS	1/4"
Operating pressure	bar	6,2
Internal hose size (Ø)	mm	10
Mean air consumption	l/min	130

1927CD/K3 019270107

~~£ 598,00~~ **£ 257,00**
12"
Assortment of 1 reversible impact wrench and 3 impact sockets, in plastic case

1927P 019270008

~~£ 602,00~~ **£ 239,00**
12"
Reversible impact wrench

- Double hammer impulse device
- Lightweight and well-balanced for enhanced ease of use
- Reversible lever
- Three power adjustable screwing positions
- Exhaust through handle
- Vibration-damping handle

Free speed	rpm	7.500
Impulse device		Double hammer
Max. torque	Nm	1750
Bolt capacity	Cl 8.8	M24●36 mm
Bolt capacity	Cl 12.9	M20●30 mm
Air inlet	GAS	1/4"
Operating pressure	bar	6,2
Internal hose size (Ø)	mm	10
Mean air consumption	l/min	290

1927P/K3 019270118

~~£ 624,00~~ **£ 268,00**
12"
Reversible impact wrench, supplied with 3 impact sockets, in plastic case

1927B 019270022

~~£ 254,00~~ **£ 109,00**
12"
Reversible impact wrench

- "Pin Clutch" impulse device
- Rubber handle
- Reversible lever
- Three power adjustable screwing positions
- Exhaust through handle

Free speed	rpm	7.000
Impulse device		Pin Clutch
Max. torque	Nm	705
Bolt capacity	Cl 8.8	M22●34 mm
Bolt capacity	Cl 12.9	M18●27 mm
Air inlet	GAS	1/4"
Operating pressure	bar	6,2
Internal hose size (Ø)	mm	10
Mean air consumption	l/min	133

1927B/K5 019270122

~~£ 327,00~~ **£ 141,00**
12"
Reversible impact wrench, made from aluminium, supplied with 5 impact sockets, in plastic case

3/4"**728ME/C6**

007280906

NEW!£ 313,00 **£ 160,00****Set of 6 impact socket drivers for hexagon screws, in metal case**

O 12-14-17-19-22-24 mm



≡ 335x145x60 mm

728B/C10

007280930

NEW!£ 420,00 **£ 181,00****Set of 10 bi-hex impact sockets, in metal case**

O 17-19-22-24-27-30-32-36-41-46 mm



≡ 275x120x65 mm

1928XM

019280030

£ 787,00 **£ 338,00****Compact reversible impact wrench**

- Double hammer impulse device
- Amazingly compact and powerful
- One-hand reverse button
- Three power adjustable screwing positions
- Exhaust through handle

Free speed	rpm	4,800
Impulse device		Double hammer
Max. torque	Nm	1600
Bolt capacity	Cl 8.8	M27●41 mm
Bolt capacity	Cl 12.9	M24●36 mm
Air inlet	GAS	3/8"
Operating pressure	bar	6,2
Internal hose size (Ø)	mm	10
Mean air consumption	l/min	175

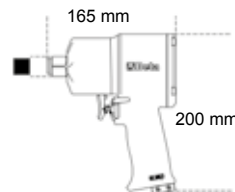
**1600 Nm****ULTRA COMPACT AND POWERFUL**

📖 2,9 kg

3/4"**1928CD**

019280007

£ 1.265,00 **£ 545,00****Reversible impact wrench**

- Double hammer impulse device
- High weight/power ratio
- Reversible lever
- Three power adjustable screwing positions
- Exhaust through handle
- Silenced

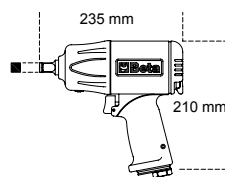
**3/4"**

📖 3,5 kg

Free speed	rpm	4,500
Impulse device		Double hammer
Max. torque	Nm	1.800
Bolt capacity	Cl 8.8	M27●41 mm
Bolt capacity	Cl 12.9	M24●36 mm
Air inlet	GAS	3/8"
Operating pressure	bar	6,2
Internal hose size (Ø)	mm	10
Mean air consumption	l/min	215

1928DA

019280022

£ 949,00 **£ 408,00****Reversible impact wrench**

- Double hammer impulse device
- Sturdy and compact; high torque
- Reversible lever
- Three power adjustable positions
- Exhaust through handle
- Slip-proof ergonomic handle

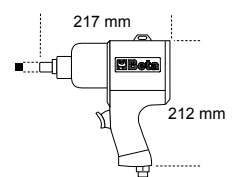
**3/4"**

📖 4,3 kg

Free speed	rpm	5,000
Impulse device		Double hammer
Max. torque	Nm	1.695
Bolt capacity	Cl 8.8	M30●46 mm
Bolt capacity	Cl 12.9	M27●41 mm
Air inlet	GAS	3/8"
Operating pressure	bar	6,2
Internal hose size (Ø)	mm	10
Mean air consumption	l/min	210

**3/4"****1928P**

019280006

£ 1.310,00 **£ 565,00****NEW!****Reversible impact wrench,
made from composite material**

- Double hammer impulse device
- Lightweight and well-balanced for enhanced ease of use
- Reversible lever
- Three power adjustable screwing positions
- Exhaust through handle
- Vibration-damping handle

Free speed	rpm	5.000
Impulse device		Double hammer
Max. torque	Nm	2.100
Bolt capacity	Cl 8.8	M30●46 mm
Bolt capacity	Cl 12.9	M27●41 mm
Air inlet	GAS	3/8"
Operating pressure	bar	6,2
Internal hose size (Ø)	mm	10
Mean air consumption	l/min	221

**2100 Nm
ULTRA COMPACT
AND POWERFUL**

3,7 kg

1930PA

019300032

£ 1.340,00 **£ 575,00****1"****Reversible impact wrench**

- Double hammer impulse device
- Auxiliary handle
- Reversible lever
- Three power adjustable screwing/unscrewing positions
- Exhaust through handle

Free speed	rpm	3.500
Impulse device		Double hammer
Max. torque	Nm	2445
Bolt capacity	Cl 8.8	M36●55mm
Bolt capacity	Cl 12.9	M30●46mm
Air inlet	GAS	1/2"
Operating pressure	bar	6,2
Internal hose size (Ø)	mm	13
Mean air consumption	l/min	350

**1"**

9,6 kg

1930LH

019300030

£ 1.520,00 **£ 655,00****1"****Reversible impact wrench**

- Double hammer impulse device
- 210 mm (8.3") long anvil
- 70-degree angled handle design to relieve stress and fatigue on the operator's wrists
- Auxiliary side handle
- 3 power adjustable screwing/unscrewing positions
- Lower exhaust
- Excellent weight/power ratio

Free speed	rpm	6.000
Impulse device		Double hammer
Max. torque	Nm	2441
Bolt capacity	Cl 8.8	M36●55mm
Bolt capacity	Cl 12.9	M30●46mm
Air inlet	GAS	1/2"
Operating pressure	bar	6,2
Internal hose size (Ø)	mm	13
Mean air consumption	l/min	280



7,1 kg

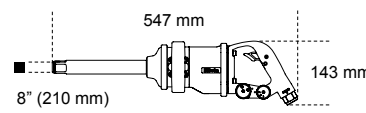

Reversible air impact ratchets

- Double rocking dog™ impulse device
- Easy tightening: The impact mechanism system eliminates wrist twisting at end of screwing and shortens operating time
- Compact and powerful: maximum torque is significantly higher than maximum torque as achieved with a conventional ratchet
- Ergonomic rubber handle



12" 136 Nm 1,5 kg

1922P3 019220013 ~~£ 557,00~~ **£ 240,00**

Free speed	rpm	600
Maximum torque	Nm	136
Bolt capacity	Cl 8.8	M12●18 mm
Bolt capacity	Cl 12.9	M10●16 mm
Air inlet	GAS	1/2"
Operating pressure	bar	6,2
Internal hose size (Ø)	mm	10
Mean air consumption	l/min	113

**HIGH TORQUE
WITHOUT
AFFECTING WRIST**



14" 68 Nm 600 g

1922P1 019220006 ~~£ 341,00~~ **£ 147,00**

38" 68 Nm

1922P2 019220010 ~~£ 341,00~~ **£ 147,00**

Free speed	rpm	700
Maximum torque	Nm	68
Bolt capacity	Cl 8.8	M10●16 mm
Bolt capacity	Cl 12.9	M8●13 mm
Air inlet	GAS	1/2"
Operating pressure	bar	6,2
Internal hose size (Ø)	mm	10
Mean air consumption	l/min	88

1933IH 019330006 ~~£ 246,50~~ **£ 119,00**

High-power die grinder

- Collect chuck, Ø 3 mm and 6 mm



Free speed	rpm	20.000
Chuck capacity	mm	3-6
Power	kW	0,75
Air inlet	GAS	1/4"
Operating pressure	bar	6,2
Internal hose size (Ø)	mm	10
Mean air consumption	l/min	370

1942A 019420000 ~~£ 406,00~~ **£ 175,00**

Air saw

- Powerful and handy
- Designed for cutting bodies, exhaust pipes and silencers, aluminium and plastic
- Complete with rubber handle, PVC exhaust pipe and air-feeding hose
- Rear exhaust



Strokes per minute		10.000
Stroke length	mm	10
Air inlet	GAS	1/4"
Operating pressure	bar	6,2
Internal hose size (Ø)	mm	8
Mean air consumption	l/min	75

1936/5A 019360025 ~~£ 501,00~~ **£ 215,00**

Angle grinder

- Extremely compact and handy
- Air governor for automatically controlling top speed
- Right-hand/left-hand auxiliary handle
- Spindle lock button
- Accessory for quickly changing discs
- Safety cap can be quickly adjusted in nine different positions through quick release
- Rear exhaust

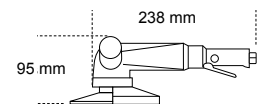

Free speed	rpm	10.000
Power	kW	0,66
Spindle thread		M14
Air inlet	GAS	1/4"
Operating pressure	bar	6,2
Internal hose size (Ø)	mm	10
Mean air consumption	l/min	390

1937 5

019370001

~~£ 635,00~~ **£ 273,00**

Roto-orbital palm sander, lubrication free, made from composite material

- No lubrication required
- Extremely compact and easy to handle
- 6-hole Velcro pad
- Continuous motor speed adjustment
- Nonslip, soft material handle
- Designed for connection to suction systems with swivel fittings
- Revolving exhaust

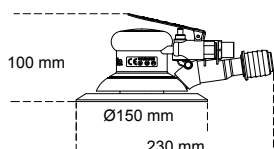

Free speed	rpm	12.000
Power	kW	0,18
Pad size	mm	150
Spindle thread		5/16"-24
Air inlet	GAS	1/4"
Operating pressure	bar	6,2
Internal hose size (Ø)	mm	10
Mean air consumption	l/min	170

1946 C4,8

019460006

~~£ 934,00~~ **£ 402,00**

Automatic air suction riveter

- Professional air riveter for use with 2.4 - 3.2 - 4.0 - 4.8 mm long steel, stainless steel, aluminium and copper rivets
- Pointed cone-shaped spout
- Powerful and handy, with handle made of composite material
- Complete with safety nail container and oil gun

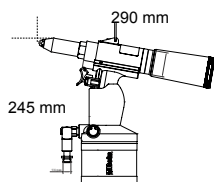

Material/Riveter	2,4	3,2	4	4,8
Copper	✓	✓	✓	✓
Aluminium	✓	✓	✓	✓
Steel	✓	✓	✓	✓
Stainless steel	✓	✓	✓	✓

Traction power	N	8.900
Stroke length	mm	15
Maximum rivet capacity	Ø stainless steel	4,8 mm
Air inlet	GAS	1/4"
Operating pressure	bar	6,2
Internal hose size (Ø)	mm	10
Air consumption	l/cycle	2,6

1949XS

019490025

NEW!
~~£ 7,90~~ **£ 3,40**
Progressive blow pen

- Made from light alloy
- Air flow can be adjusted by rotating head

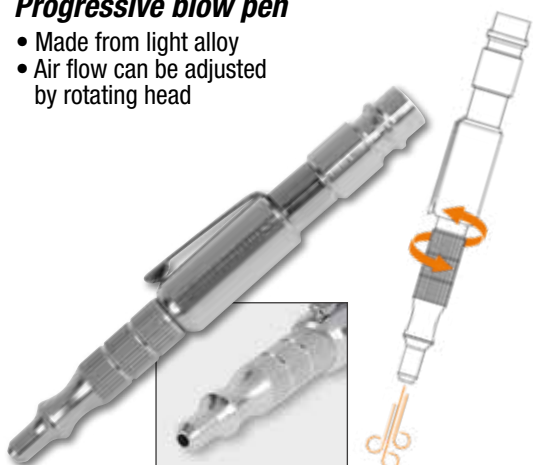

Threaded brass insert	1/4" GAS
Operating pressure	3-8 bar
Maximum operating pressure	10 bar
Operating temperature	-20°C + 70°C

1949U5

019490030

~~£ 48,50~~ **£ 22,00**
Progressive blow gun with 5 nozzles

- Hard-wearing, shockproof composite material body
- 3 steel nozzles, 100/160/320 mm, scratchproof, protective rubber tips
- 1 "Turbo" nozzle made of fibreglass-reinforced nylon with safety tip
- 1 revolving nozzle, 100 mm, made of fibreglass-reinforced nylon
- With quick fixing system

Threaded brass insert	1/4" GAS
Operating pressure	10 bar
Maximum operating pressure	15 bar
Mean air consumption	280 l/min
Operating temperature	-10°C + 85°C



- EVA OUTSOLE WITH DURABLE NITRILE RUBBER TREAD
- HEEL STABILITY SUPPORT
- COMPOSITE FIBRE PENETRATION-PROOF INSOLE

NEW!

7371V

£177,50 **£ 76,00**

O-Gravity mesh fabric shoe, ultrabreathable

The fluorescent colour and captivating design add a touch of innovation to the shoe.

- Traditional lacing
- Wide fit



EU	UK	
38	5	073710038
39	6	073710039
40	6,5	073710040
41	7	073710041
42	8	073710042
43	9	073710043
44	10	073710044
45	10,5	073710045
46	11	073710046
47	12	073710047
48	13	073710048



7372B

£171,00 **£ 74,00**

O-Gravity woven fabric shoe, ultralightweight, hard-wearing and ultrabreathable

- Heel stability support, traditional lacing
- Wide fit



EU	UK	
38	5	073720038
39	6	073720039
40	6,5	073720040
41	7	073720041
42	8	073720042
43	9	073720043
44	10	073720044
45	10,5	073720045
46	11	073720046
47	12	073720047
48	13	073720048



S1PS HRO FO SR ESD



EN ISO
20345
2022

450 g

S1P HRO SRC



450 g

7352B

£165,00 **£ 71,00**

O-Gravity mesh fabric shoe, highly breathable, with TPU inserts

- Composite toe cap
- Stretch slip-on collar



EU	UK	
38	5	073520138
39	6	073520139
40	6,5	073520140
41	7	073520141
42	8	073520142
43	9	073520143
44	10	073520144
45	10,5	073520145
46	11	073520146
47	12	073520147
48	13	073520148



7352G

£166,50 **£ 76,00**

O-Gravity mesh fabric shoe, waterproof, with TPU inserts

- Composite toe cap
- Traditional lacing
- Wide fit



EU	UK	
38	5	073520338
39	6	073520339
40	6,5	073520340
41	7	073520341
42	8	073520342
43	9	073520343
44	10	073520344
45	10,5	073520345
46	11	073520346
47	12	073520347
48	13	073520348



S1P HRO SRC



450 g

S1P HRO SRC ESD



450 g

- EVA OUTSOLE WITH DURABLE NITRILE RUBBER TREAD
- HEEL STABILITY SUPPORT
- COMPOSITE FIBRE PENETRATION-PROOF INSOLE

7354N

£ 176,00 ~~£ 176,00~~ **£ 76,00**

Mesh fabric shoe, waterproof, with TPU inserts

- Composite toe cap
- Stretch slip-on collar



EU	UK	SKU
38	5	073540038
39	6	073540039
40	6,5	073540040
41	7	073540041
42	8	073540042
43	9	073540043
44	10	073540044
45	10,5	073540045
46	11	073540046
47	12	073540047
48	13	073540048

S3 HRO SRC ESSENTIAL 460 g

7381N

£ 215,00 ~~£ 215,00~~ **£ 92,00**

Water resistant EXTREME O-GRAVITY work shoes

- Composite toe cap
- Waterproof, with bootie membrane, windproof, highly breathable
- Wide fit

EU	UK	SKU
38	5	073810038
39	6	073810039
40	6,5	073810040
41	7	073810041
42	8	073810042
43	9	073810043
44	10	073810044
45	10,5	073810045
46	11	073810046
47	12	073810047
48	13	073810048

WATER RESISTANT



S3 HRO SRC WR EXTREME 500 g

7382N

£ 242,00 ~~£ 242,00~~ **£ 104,00**

Water resistant EXTREME O-GRAVITY work shoes

- Composite toe cap
- Waterproof, with bootie membrane, windproof, highly breathable
- Wide fit

EU	UK	SKU
38	5	073820038
39	6	073820039
40	6,5	073820040
41	7	073820041
42	8	073820042
43	9	073820043
44	10	073820044
45	10,5	073820045
46	11	073820046
47	12	073820047
48	13	073820048

WATER RESISTANT



S3 HRO SRC WR EXTREME 550 g

7356G

£ 181,00 ~~£ 181,00~~ **£ 78,00**

O-Gravity shoe, ultralightweight, made of water-repellent microfibre

- Composite toe cap
- Stretch slip-on collar

EU	UK	SKU
38	5	073560038
39	6	073560039
40	6,5	073560040
41	7	073560041
42	8	073560042
43	9	073560043
44	10	073560044
45	10,5	073560045
46	11	073560046
47	12	073560047
48	13	073560048



S3 HRO SRC ESSENTIAL 460 g

7357G

£ 201,50 ~~£ 201,50~~ **£ 87,00**

O-Gravity ankle shoe, ultralightweight, made of water-repellent microfibre

- Composite toe cap
- Traditional lacing

EU	UK	SKU
38	5	073570038
39	6	073570039
40	6,5	073570040
41	7	073570041
42	8	073570042
43	9	073570043
44	10	073570044
45	10,5	073570045
46	11	073570046
47	12	073570047
48	13	073570048



S3 HRO SRC ESSENTIAL 480 g

ACTIVE

• COMPOSITE TOE CAP
• COMPOSITE FIBRE PENETRATION-PROOF INSOLE



7316NG

~~£ 109,50~~ **£ 47,00**

Mesh and suede shoe, highly breathable, with heel stability support

S1P SRC ESD



EU	UK	
35	2,5	073160635
36	3,5	073160636
37	4,5	073160637
38	5	073160638
39	6	073160639
40	6,5	073160640
41	7	073160641
42	8	073160642
43	9	073160643
44	10	073160644
45	10,5	073160645
46	11	073160646
47	12	073160647
48	13	073160648

7316NB

~~£ 109,50~~ **£ 47,00**

Mesh and suede shoe, highly breathable, with heel stability support

S1P SRC ESD



EU	UK	
35	2,5	073160735
36	3,5	073160736
37	4,5	073160737
38	5	073160738
39	6	073160739
40	6,5	073160740
41	7	073160741
42	8	073160742
43	9	073160743
44	10	073160744
45	10,5	073160745
46	11	073160746
47	12	073160747
48	13	073160748

7317NA

~~£ 103,00~~ **£ 44,50**

Suede shoe, perforated, with microfibre reinforcement in heel area

S1P SRC



EU	UK	
35	2,5	073170135
36	3,5	073170136
37	4,5	073170137
38	5	073170138
39	6	073170139
40	6,5	073170140
41	7	073170141
42	8	073170142
43	9	073170143
44	10	073170144
45	10,5	073170145
46	11	073170146
47	12	073170147
48	13	073170148

7322SA

~~£ 117,50~~ **£ 51,00**

Fabric shoe, highly resistant to abrasion

S3 SRC



EU	UK	
35	2,5	073220435
36	3,5	073220436
37	4,5	073220437
38	5	073220438
39	6	073220439
40	6,5	073220440
41	7	073220441
42	8	073220442
43	9	073220443
44	10	073220444
45	10,5	073220445
46	11	073220446
47	12	073220447
48	13	073220448

7320NA

~~£ 108,50~~ **£ 46,50**

Nubuck shoe, water-repellent, with anti-abrasion reinforcement in toe cap area

S3 SRC



EU	UK	
35	2,5	073200435
36	3,5	073200436
37	4,5	073200437
38	5	073200438
39	6	073200439
40	6,5	073200440
41	7	073200441
42	8	073200442
43	9	073200443
44	10	073200444
45	10,5	073200445
46	11	073200446
47	12	073200447
48	13	073200448

7321NA

~~£ 112,00~~ **£ 48,00**

Nubuck shoe, water-repellent, with quick opening system and antiabrasion reinforcement in toe cap area

S3 RS SRC



EU	UK	
35	2,5	073210435
36	3,5	073210436
37	4,5	073210437
38	5	073210438
39	6	073210439
40	6,5	073210440
41	7	073210441
42	8	073210442
43	9	073210443
44	10	073210444
45	10,5	073210445
46	11	073210446
47	12	073210447
48	13	073210448

QUICK OPENING SYSTEM

FLEX

- COMPOSITE TOE CAP
- COMPOSITE FIBRE PENETRATION-PROOF INSOLE
- ANTI-ABRASION INSERT IN TOE CAP AREA



EN ISO 20345 2011



7212B

~~£ 98,00~~ **£ 42,00**

Suede shoe, perforated, with mesh inserts



S1P SRC ESD



490 g

EU	UK	Product Code
35	2,5	072120235
36	3,5	072120236
37	4,5	072120237
38	5	072120238
39	6	072120239
40	6,5	072120240
41	7	072120241
42	8	072120242
43	9	072120243
44	10	072120244
45	10,5	072120245
46	11	072120246
47	12	072120247
48	13	072120248

7212G

~~£ 98,00~~ **£ 42,00**

Suede shoe, perforated



S1P SRC ESD



490 g

EU	UK	Product Code
35	2,5	072120335
36	3,5	072120336
37	4,5	072120337
38	5	072120338
39	6	072120339
40	6,5	072120340
41	7	072120341
42	8	072120342
43	9	072120343
44	10	072120344
45	10,5	072120345
46	11	072120346
47	12	072120347
48	13	072120348

7213G

~~£ 98,00~~ **£ 42,00**

Suede shoe, perforated, with highly breathable mesh inserts



S1P SRC ESD



490 g

EU	UK	Product Code
35	2,5	072130135
36	3,5	072130136
37	4,5	072130137
38	5	072130138
39	6	072130139
40	6,5	072130140
41	7	072130141
42	8	072130142
43	9	072130143
44	10	072130144
45	10,5	072130145
46	11	072130146
47	12	072130147
48	13	072130148

7214G

~~£ 109,50~~ **£ 47,00**

Action nubuck shoe, water-repellent, with anti-abrasion insert in toe cap area



S3 SRC ESD



500 g

EU	UK	Product Code
35	2,5	072140235
36	3,5	072140236
37	4,5	072140237
38	5	072140238
39	6	072140239
40	6,5	072140240
41	7	072140241
42	8	072140242
43	9	072140243
44	10	072140244
45	10,5	072140245
46	11	072140246
47	12	072140247
48	13	072140248

7218G

~~£ 114,00~~ **£ 51,00**

Action nubuck ankle shoe, water-repellent, with anti-abrasion insert in toe cap area



S3 SRC RS ESD



550 g

EU	UK	Product Code
35	2,5	072180135
36	3,5	072180136
37	4,5	072180137
38	5	072180138
39	6	072180139
40	6,5	072180140
41	7	072180141
42	8	072180142
43	9	072180143
44	10	072180144
45	10,5	072180145
46	11	072180146
47	12	072180147
48	13	072180148

HEAVY DUTY

- ANTI-ABRASION INSERT ON HEEL AREA AND REINFORCEMENT POLYURETHANE TOE CAP COVER
- FIBREGLASS TOE CAP
- COMPOSITE FIBRE PENETRATION PROOF INSOLE

EN ISO 20345 2011



7293HM

~~£ 248,00~~ **£ 107,00**

Greased full-grain leather shoe with high-performance VIBRAM® rubber tread

EU	UK	
39	6	072930639
40	6,5	072930640
41	7	072930641
42	8	072930642
43	9	072930643
44	10	072930644
45	10,5	072930645
46	11	072930646
47	12	072930647
48	13	072930648

S3 HRO HI SRC



7294HM

~~£ 265,00~~ **£ 114,00**

Water-repellent greased full-grain leather ankle shoes with high-performance VIBRAM® rubber tread

EU	UK	
39	6	072940639
40	6,5	072940640
41	7	072940641
42	8	072940642
43	9	072940643
44	10	072940644
45	10,5	072940645
46	11	072940646
47	12	072940647
48	13	072940648

S3 HRO HI SRC



TREKKING

- STEEL TOE CAP
- COMPOSITE FIBRE PENETRATION-PROOF INSOLE

EN ISO 20345 2011



7249GK

~~£ 92,00~~ **£ 39,50**

Suede ankle shoe with nylon inserts, quick opening system and reinforcement polyurethane toe cap cover

EU	UK	
35	2,5	072490235
36	3,5	072490236
37	4,5	072490237
38	5	072490238
39	6	072490239
40	6,5	072490240
41	7	072490241
42	8	072490242
43	9	072490243
44	10	072490244
45	10,5	072490245
46	11	072490246
47	12	072490247
48	13	072490248

S1P RS SRC



QUICK OPENING SYSTEM

7236BK

~~£ 106,50~~ **£ 46,00**

Action Nubuck ankle shoe, waterproof, with quick opening system and reinforcement polyurethane toe cap cover

EU	UK	
35	2,5	072360335
36	3,5	072360336
37	4,5	072360337
38	5	072360338
39	6	072360339
40	6,5	072360340
41	7	072360341
42	8	072360342
43	9	072360343
44	10	072360344
45	10,5	072360345
46	11	072360346
47	12	072360347
48	13	072360348

S3 RS SRC



QUICK OPENING SYSTEM

7238WR

~~£ 139,00~~ **£ 63,00**

Suede ankle shoe with nylon inserts, durable rubber outsole and quick opening system WR (water-resistant) footwear

- Composite toe cap

WATER RESISTANT



S3 HRO RS WR SRC

QUICK OPENING SYSTEM

EU	UK	
35	2,5	072380235
36	3,5	072380236
37	4,5	072380237
38	5	072380238
39	6	072380239
40	6,5	072380240
41	7	072380241
42	8	072380242
43	9	072380243
44	10	072380244
45	10,5	072380245
46	11	072380246
47	12	072380247
48	13	072380248

EASY PLUS

- COMPOSITE TOE CAP
- COMPOSITE FIBRE PENETRATION-PROOF INSOLE



7220PEK

~~£ 89,00~~ **£ 38,50**

Leather shoe, water-repellent, with nylon insets and anti-abrasion reinforcement in toe cap area

S3 SRC



EU	UK	Product Code
35	2,5	072200235
36	3,5	072200236
37	4,5	072200237
38	5	072200238
39	6	072200239
40	6,5	072200240
41	7	072200241
42	8	072200242
43	9	072200243
44	10	072200244
45	10,5	072200245
46	11	072200246
47	12	072200247
48	13	072200248

7221PEK

~~£ 94,00~~ **£ 40,50**

Leather ankle shoe, water-repellent, with nylon insets, anti-abrasion reinforcement in toe cap area and quick opening system

S3 RS SRC



**QUICK
OPENING
SYSTEM**

EU	UK	Product Code
35	2,5	072210235
36	3,5	072210236
37	4,5	072210237
38	5	072210238
39	6	072210239
40	6,5	072210240
41	7	072210241
42	8	072210242
43	9	072210243
44	10	072210244
45	10,5	072210245
46	11	072210246
47	12	072210247
48	13	072210248

7222PEK

~~£ 86,50~~ **£ 37,00**

Suede shoe, perforated, with highly breathable mesh inserts

S1P SRC



EU	UK	Product Code
35	2,5	072220135
36	3,5	072220136
37	4,5	072220137
38	5	072220138
39	6	072220139
40	6,5	072220140
41	7	072220141
42	8	072220142
43	9	072220143
44	10	072220144
45	10,5	072220145
46	11	072220146
47	12	072220147
48	13	072220148

7223PEK

~~£ 93,00~~ **£ 40,00**

Suede shoe with highly breathable mesh inserts and anti-abrasion reinforcement in toe cap area

S1P SRC



EU	UK	Product Code
35	2,5	072230135
36	3,5	072230136
37	4,5	072230137
38	5	072230138
39	6	072230139
40	6,5	072230140
41	7	072230141
42	8	072230142
43	9	072230143
44	10	072230144
45	10,5	072230145
46	11	072230146
47	12	072230147
48	13	072230148



**SAFETY FOOTWEAR
AND WORKWEAR**

• STEEL TOE CAP
• COMPOSITE FIBRE PENETRATION-PROOF INSOLE

EN ISO
20345
2011



BASIC

7241CK

~~£ 69,50~~ **£ 30,00**

Leather shoe, water-repellent

EU	UK	Product Code
35	2,5	072411535
36	3,5	072411536
37	4,5	072411537
38	5	072411538
39	6	072411539
40	6,5	072411540
41	7	072411541
42	8	072411542
43	9	072411543
44	10	072411544
45	10,5	072411545
46	11	072411546
47	12	072411547
48	13	072411548

S3 SRC



7243CK

~~£ 70,50~~ **£ 30,50**

Leather ankle shoe, water-repellent, with quick opening system

EU	UK	Product Code
35	2,5	072431335
36	3,5	072431336
37	4,5	072431337
38	5	072431338
39	6	072431339
40	6,5	072431340
41	7	072431341
42	8	072431342
43	9	072431343
44	10	072431344
45	10,5	072431345
46	11	072431346
47	12	072431347
48	13	072431348

S3 RS SRC



QUICK OPENING SYSTEM

7245BK

~~£ 77,50~~ **£ 33,50**

Lace-up leather ankle shoe, "welder style", water-repellent, with quick opening system and front protection with strap closure

EU	UK	Product Code
35	2,5	072451235
36	3,5	072451236
37	4,5	072451237
38	5	072451238
39	6	072451239
40	6,5	072451240
41	7	072451241
42	8	072451242
43	9	072451243
44	10	072451244
45	10,5	072451245
46	11	072451246
47	12	072451247
48	13	072451248

S3 RS SRC



QUICK OPENING SYSTEM

7246BK

~~£ 69,50~~ **£ 30,00**

Suede shoe, perforated

EU	UK	Product Code
35	2,5	072461235
36	3,5	072461236
37	4,5	072461237
38	5	072461238
39	6	072461239
40	6,5	072461240
41	7	072461241
42	8	072461242
43	9	072461243
44	10	072461244
45	10,5	072461245
46	11	072461246
47	12	072461247
48	13	072461248

S1P SRC



7422P

~~£ 15,00~~ **£ 7,00**

2 pairs of calf-length socks made from recycled terry cotton, with tremor-effect terry cloth in toe and heel areas

EU	Size	Product Code
39-42	M	074220102
43-46	L	074220104

NEW!



7426P

~~£ 14,00~~ **£ 6,00**

2 pairs of maxi sneaker socks made from recycled terry cotton, with terry cotton in sole area and tremor effect in toe and heel areas

EU	Size	Product Code
39-42	M	074260102
43-46	L	074260104

NEW!



7430T

~~£ 18,00~~ **£ 8,00**

3 pairs of sneaker socks made from recycled cotton, with tremor-effect terry cloth in toe and heel areas

EU	Size	Product Code
39-42	M	074300202
43-46	L	074300204

NEW!



7818G

~~£ 86,50~~ **£ 39,00**

Work trousers, multipocket style, with stretch fabric inserts



GREY

XS	46	078180000
S	48	078180001
M	50	078180002
L	52	078180003
XL	54	078180004
XXL	56	078180005
XXXL	58	078180006

- T/C canvas, 65% polyester, 35% cotton, 260 g/m²
 - Stretch fabric inserts, 90% nylon, 10% spandex; 260 g/m²
- Knee pad pockets and leg bottoms reinforced in polyester 300D

STRENGTH

The polyester and cotton fabric is synonymous with hard-wearing trousers. The addition of abrasion-resistant inserts on the knees and leg bottoms translates into further increased strength.

COMFORT AND CONVENIENCE

The addition of stretch inserts in inside legs and on the back results in remarkably comfortable trousers. Accurate details and addition of pockets, ruler pocket and hammer loop, ensuring unique convenience for the most demanding workers.

7818CM

~~£ 100,00~~ **£ 43,00**

Work trousers, multipocket style, hard-wearing, comfortable and practical, with unique camouflage design



CAMOUFLAGE

XS	46	078180300
S	48	078180301
M	50	078180302
L	52	078180303
XL	54	078180304
XXL	56	078180305
XXXL	58	078180306

7819G

~~£ 86,00~~ **£ 39,00**

Hard-wearing, comfortable, practical work trousers, multipocket style, with detachable flying pockets at waist

- T/C canvas, 65% polyester, 35% cotton, 260 g/m²
- Stretch fabric inserts, 90% nylon, 10% spandex; 260 g/m²
- Knee pad pockets and leg bottoms reinforced in polyester 300D
- Grey with black inserts and fluorescent orange details



XS	46	078190000
S	48	078190001
M	50	078190002
L	52	078190003
XL	54	078190004
XXL	56	078190005
XXXL	58	078190006



NEW!

CONVENIENCE

Trousers designed to provide unique convenience, based on the 14 pockets. The accurate details, detachable pockets at waist and ruler pockets ensure unique convenience, even for the most demanding workers.

STRENGTH

The polyester and cotton fabric is synonymous with hard-wearing trousers. The addition of anti-abrasion inserts on the knees and leg bottoms translates into further increased strength.

COMFORT

The addition of stretch inserts in inside legs and on the back results in remarkably comfortable trousers.

7600N

~~£ 112,00~~ **£ 50,00**

"Work trekking" trousers made from stretch fabric

- 90% nylon, 10% stretch fabric, 265 g/m², black



TREKKING HEAVY
SLIM FIT

XS	46	076000100
S	48	076000101
M	50	076000102
L	52	076000103
XL	54	076000104
XXL	56	076000105
XXXL	58	076000106

UNPARALLELED COMFORT

The stretch, lightweight fabric follows every movement, thereby translating into maximum comfort. Pre-shaped knee seams, for improved comfort.

STRENGTH AND DURABILITY

The addition of highly resistant stretch fabric results in even harder-wearing and more durable trousers.

DESIGN AND CONVENIENCE

The innovative design inspired by mountain clothing is the hallmark of the "work trekking" trousers, where comfort matches simple, captivating shapes.

7610N

~~£ 102,00~~ **£ 44,00**

"Work trekking" trousers, LIGHT, made from stretch fabric

- 90% nylon, 10% stretch fabric, 140 g/m², black



TREKKING LIGHT
SLIM FIT

XS	46	076100100
S	48	076100101
M	50	076100102
L	52	076100103
XL	54	076100104
XXL	56	076100105
XXXL	58	076100106

7650 ~~£ 132,50~~ **£ 57,00**

Stretch work trousers, multipocket style, grey

- Stretch fabric 90% nylon, 10% spandex, **260 g/m²**
- Knee pad pockets, rear pockets and leg bottoms reinforced in polyester 600D
- Tearproof crotch
- Higher waisted rear for increased back protection
- Two large front pockets, one with small pocket with horizontal zip closure
- Two rear pockets with strap closure
- Large left-leg pocket with strap closure and vertical pocket with zip closure
- Front right-leg pocket with horizontal zip closure
- Large knee pad pockets with strap closure
- Ruler pocket and hammer loop

HEAVY



XS	46	076500000
S	48	076500001
M	50	076500002
L	52	076500003
XL	54	076500004
XXL	56	076500005
XXXL	58	076500006

7660G ~~£ 109,00~~ **£ 47,00**

Stretch work trousers, lightweight, multipocket, grey

- Stretch fabric 86% nylon, 14% spandex, **140 g/m²**
- Knee pad pockets, rear pockets reinforced in polyester 300D
- Tearproof crotch
- Two large front pockets with zip closure

LIGHT



XS	46	076600000
S	48	076600001
M	50	076600002
L	52	076600003
XL	54	076600004
XXL	56	076600005
XXXL	58	076600006



7850G ~~£ 60,00~~ **£ 26,00**

Cargo trousers made of 100% cotton, grey

- Slim fit
- 100% cotton fabric
- Grey with fluorescent green details

CLASSIC, THOUGH FASHIONABLE LOOK

Simple, essential lines and attention to detail make these trousers ideal for both work and free time.

COMFORT

The fabric made of 100% cotton and the stretch waistband have been specially designed to provide unparalleled convenience and comfort in all working situations.

CONVENIENCE

Special attention to the choice and positions of the pockets results in slim yet extremely practical trousers.

NEW!



SLIM FIT



XS	46	078500100
S	48	078500101
M	50	078500102
L	52	078500103
XL	54	078500104
XXL	56	078500105
XXXL	58	078500106
XXXXL	60	078500107

7642G ~~£ 30,50~~ **£ 17,00**

Crew-neck sweatshirt with black inserts on shoulders and fluorescent green detail, melange grey

60% cotton, 40% polyester, 240 g/m²
Beta's crew-neck sweatshirt is the perfect combination between comfort and a modern look.

COMFORT

The soft, warm fabric ensures unique comfort during work. The stretch ribbed neck, cuffs and bottom result in an even more practical and functional garment.

MODERN LOOK

The fluorescent details as well as the coloured seams and the reflex inserts provide a touch of uniqueness and style.

NEW!



XS	076420000
S	076420001
M	076420002
L	076420003
XL	076420004
XXL	076420005
XXXL	076420006

7665
~~£ 69,50~~ **£ 32,00**
Hoodie, long-zipped

- 60% cotton, 40% polyester, 280 g/m²
- Stretch cuffs
- Two large waist pockets with zip closure
- Chest pocket with vertical zip closure
- Fixed hood with round drawcords

BLACK
7665N
TOP
line

GREY
7665G

	BLACK	GREY
XS	076650000	076650100
S	076650001	076650101
M	076650002	076650102
L	076650003	076650103
XL	076650004	076650104
XXL	076650005	076650105
XXXL	076650006	076650106

7637G
~~£ 121,00~~ **£ 52,00**
Technical fleece sweatshirt with softshell fabric inserts

- Main fabric: fleece, 100% polyester, 250 g/m²
- Insert: softshell 100D, with bound fleece, 270 g/m²

PROTECTION

The fabric used makes the garment warm and comfortable, while providing cold protection during work.

COMFORT AND DURABILITY

Ergonomic, slim design, for an extremely comfortable and functional garment. Softshell inserts, for further strength and increased durability.

MODERN LOOK

Captivating design and the combination of two different materials make the sweatshirt ideal for both work and free time.



	BLACK	GREY
XS	076370000	
S	076370001	
M	076370002	
L	076370003	
XL	076370004	
XXL	076370005	
XXXL	076370006	

7636N
~~£ 31,50~~ **£ 14,00**
Short-zipped microfleece sweater, black

100% polyester fleece, 180 g/m²
 This microfleece sweater combines a simple style with comfort and convenience.

SIMPLE, ESSENTIAL LINES

The black colour and the reflex details result in a simple style, allowing this sweater to match any garment of Beta's range.

COMFORT AND PROTECTION

The extremely lightweight fleece fabric results in a remarkably comfortable and slim garment for work, without compromising cold protection.



	BLACK	GREY
XS	076360500	
S	076360501	
M	076360502	
L	076360503	
XL	076360504	
XXL	076360505	
XXXL	076360506	

NEW!

7654N ~~£ 63,50~~ **£ 29,00**

Stretch microfleece sweater, short-zipped, black

- 180 g



XS	076540000
S	076540001
M	076540002
L	076540003
XL	076540004
XXL	076540005
XXXL	076540006

7657N ~~£ 80,50~~ **£ 36,00**

Stretch fleece sweater, long-zipped, black

- 280 g
- Two large waist pockets with zip closure



- 95% polyester, 5% spandex
 - Stretch cuffs
 - Chest pocket with vertical zip closure
 - Polyester inserts on chest pocket and sleeves

XS	076570000
S	076570001
M	076570002
L	076570003
XL	076570004
XXL	076570005
XXXL	076570006

7750N ~~£ 95,00~~ **£ 43,00**

Work bomber jacket, multipocket style, waterproof, black

- Exterior fabric: 100% 50D polyester, waterproof, hard-wearing
- Interior fabric: 100% polyester
- Padding: 100% polyester
- Collar: 95% polyester fleece, 5% spandex

PROTECTION

The 100% polyester fabric and padding are the name for remarkable strength and cold protection in a simple, yet functional garment.

CONVENIENCE

The two chest pockets and the waist pockets with zip closure mean an optimal solution translating into a practical, functional garment.

CUSTOMIZATION

The interior pocket allows for a fully customized garment.



NEW!



XS	077500000
S	077500001
M	077500002
L	077500003
XL	077500004
XXL	077500005
XXXL	077500006
XXXXL	077500007

7670G ~~£ 125,50~~ **£ 54,00**

Anorak jacket made of Oxford polyester 300D waterproof, PU-coated, grey

- Detachable hood with stretch drawstring adjustment
- PU-coated (resistance to water columns up to 2,000 mm - breathability 2,000 mvp)
- Outer fabric: 100% polyester
- Inner fabric: 100% polyester



S	076700001
M	076700002
L	076700003
XL	076700004
XXL	076700005
XXXL	076700006

7673NG ~~£ 116,00~~ **£ 53,00**

Sleeveless work jacket, with GRAPHENE padding, 80 g/m², grey/black

- Outer fabric: front and shoulders: softshell fabric - 96% polyester, 4% spandex
- back: 100% nylon 20D
- Stretch inserts on armholes



S	076730001
M	076730002
L	076730003
XL	076730004
XXL	076730005
XXXL	076730006

7780QN

~~£ 165,00~~ **£ 71,00**

Work bomber jacket, black/grey



S	077800201
M	077800202
L	077800203
XL	077800204
XXL	077800205
XXXL	077800206

- Exterior chest and back fabric: 100% nylon 300D, waterproof and hard-wearing
- Shoulders, sleeves and hood: softshell, 96% polyester, 4% spandex
- Interior fabric: 100% polyester
- Padding: 100% polyester

PROTECTION

Traditional nylon fabric on the chest and back has been supplemented with softshell inserts on the shoulders, arms and hood, for an even more water and wind proof garment.

DESIGN AND INNOVATION

The combination of two fabrics and colours - grey and black - and the new hot quilting system result in an innovative, modern garment, ideal for both work and free time.

7579QN

~~£ 99,00~~ **£ 45,00**

Sleeveless work jacket, black/grey



S	075790201
M	075790202
L	075790203
XL	075790204
XXL	075790205
XXXL	075790206

Cotton

- 97% COTTON, 3% STRETCH FABRIC, 220 g/m²
- COLOUR: GREY WITH REFLECTIVE GREY DETAILS



7930MG

~~£ 84,00~~ **£ 36,00**

Work trousers, multipocket style

- Knee pad inserts with strap closure

NEW!



XS	079300400
S	079300401
M	079300402
L	079300403
XL	079300404
XXL	079300405
XXXL	079300406

- Elastic waistband
- Two large front pockets
- Two rear pockets with strap closure
- Large front pockets with strap closure
- Waist key ring
- Rear band with Beta logo
- Reflex logo on left-leg pocket



7931MG

~~£ 68,00~~ **£ 29,00**

Work bermuda shorts



NEW!

XS	079310400
S	079310401
M	079310402
L	079310403
XL	079310404
XXL	079310405
XXXL	079310406

7935MG

~~£ 149,00~~ **£ 64,00**

Work overalls

- Front closure with double tap zipper slider
- Collar with strap closure
- Cuffs with strap adjusters
- Knee pad inserts with strap closure

XS	079350400
S	079350401
M	079350402
L	079350403
XL	079350404
XXL	079350405
XXXL	079350406

NEW!

7937MG

~~£ 61,50~~ **£ 28,00**

Sleeveless work jacket

- Front zip closure, flap-covered with strap closure
- Anti-abrasion inserts made from "Oxford" polyester/PU, 220 g/m²
- Chest pockets with strap closure and pen pocket
- Large waist pockets with strap closure
- Adjustable waistband with strap



XS	079370400
S	079370401
M	079370402
L	079370403
XL	079370404
XXL	079370405
XXXL	079370406

EASY CANVAS 260 g

• T/C CANVAS, 65% POLYESTER, 35% COTTON, 260 g/m²



7900G

~~£ 78,00~~ **£ 33,50**

Work trousers

- Inserts and knee pads made of "Oxford" polyester/PU, 220 g/m²
- Knee pad pockets

SIZE	XS	S	M	L	XL	XXL	XXXL	XXXXL
ARTICLE NO.	46	48	50	52	54	56	58	60
SKU	079000800	079000801	079000802	079000803	079000804	079000805	079000806	079000807



7901G

~~£ 65,00~~ **£ 28,00**

Work Bermuda shorts

- Inserts in "Oxford" polyester/PU, 220 g/m²

- Metal zip closure
- Two deep front pockets with small tool inserts with strap closure
- Large left-leg pocket with strap closure, mobile phone pocket and badge insert
- Large rear pockets with "Oxford" reinforcement and strap closure
- Ruler pocket and hammer loop



SIZE	XS	S	M	L	XL	XXL	XXXL	XXXXL
ARTICLE NO.	46	48	50	52	54	56	58	60
SKU	079010800	079010801	079010802	079010803	079010804	079010805	079010806	079010807

7903G

~~£ 98,00~~ **£ 42,00**

Work bib and brace overalls

- Metal zip closure
- Adjustable stretch shoulder straps, with quick-release snap hooks made of plastic
- Large chest pocket with strap closure

SIZE	XS	S	M	L	XL	XXL	XXXL	XXXXL
ARTICLE NO.	46	48	50	52	54	56	58	60
SKU	079030800	079030801	079030802	079030803	079030804	079030805	079030806	079030807



7905G

~~£ 126,00~~ **£ 54,00**

Work overalls

- Cuffs with strap adjusters
- Front strap closure with flap-covered double tap zip
- Large left-side pocket with strap closure, mobile phone pocket and badge insert

- Inserts and knee pads made of "Oxford" polyester/PU, 220 g/m²
 - Stretch waistband
- Chest pockets with strap closure and pen pocket
- Two deep front pockets with small tool inserts with strap closure
- Large rear pockets with "Oxford" reinforcement and strap closure
- Ruler pocket and hammer loop
- Knee pad inserts



SIZE	XS	S	M	L	XL	XXL	XXXL	XXXXL
ARTICLE NO.	46	48	50	52	54	56	58	60
SKU	079050800	079050801	079050802	079050803	079050804	079050805	079050806	079050807

7907G

~~£ 74,50~~ **£ 32,00**

Sleeveless work jacket

- Inserts made from "Oxford" polyester/PU, 220 g/m²
- Chest pockets with strap closure, pen pocket and badge insert
- Expanding waist pockets with zips and pullers

SIZE	XS	S	M	L	XL	XXL	XXXL	XXXXL
ARTICLE NO.	46	48	50	52	54	56	58	60
SKU	079070800	079070801	079070802	079070803	079070804	079070805	079070806	079070807



7909G

~~£ 88,50~~ **£ 38,00**

Work jacket

- Inserts in "Oxford" polyester/PU, 220 g/m²
- Cuffs with strap adjusters
- Front strap closure with flap-covered double tap zip
- Adjustable waist
- Chest pockets with strap closure, pen pocket and badge insert
- Two deep waist pockets with strap closure

SIZE	XS	S	M	L	XL	XXL	XXXL	XXXXL
ARTICLE NO.	46	48	50	52	54	56	58	60
SKU	079090800	079090801	079090802	079090803	079090804	079090805	079090806	079090807



EASY TWILL 180 g

• T/C TWILL, 65% POLYESTER, 35% COTTON, 180 g/m²

7860G

~~£ 65,00~~ **£ 28,00**

Work trousers

- Inserts and knee pads made of "Oxford" polyester/PU, 220 g/m²
- Knee pad pockets

XS	46	078600800
S	48	078600801
M	50	078600802
L	52	078600803
XL	54	078600804
XXL	56	078600805
XXXL	58	078600806
XXXXL	60	078600807
5XL	62	078600808



LIGHT

7861G

~~£ 55,00~~ **£ 23,50**

Work Bermuda shorts

- Inserts in "Oxford" polyester/PU, 220 g/m²

- Metal zip closure
- Two deep front pockets with small tool inserts with strap closure
- Large left-leg pocket with strap closure, mobile phone pocket and badge insert
- Large rear pockets with "Oxford" reinforcement and strap closure
- Ruler pocket and hammer loop



LIGHT

XS	46	078610800
S	48	078610801
M	50	078610802
L	52	078610803
XL	54	078610804
XXL	56	078610805
XXXL	58	078610806
XXXXL	60	078610807
5XL	62	078610808

7863G

~~£ 80,00~~ **£ 34,50**

Work bib and brace overalls

- Metal zip closure
- Adjustable stretch shoulder straps, with quick-release snap hooks made of plastic
- Large chest pocket with strap closure

LIGHT

XS	078630800
S	078630801
M	078630802
L	078630803
XL	078630804
XXL	078630805
XXXL	078630806
XXXXL	078630807
5XL	078630808



7865G

~~£ 100,00~~ **£ 43,00**

Work overalls

- Cuffs with strap adjusters
- Front strap closure with flap-covered double tap zip
- Large left-side pocket with strap closure, mobile phone pocket and badge insert

- Inserts and knee pads made of "Oxford" polyester/PU, 220 g/m²
 - Stretch waistband
- Chest pockets with strap closure and pen pocket
- Two deep front pockets with small tool inserts with strap closure
- Large rear pockets with "Oxford" reinforcement and strap closure
- Ruler pocket and hammer loop
- Knee pad inserts



LIGHT

XS	078650800
S	078650801
M	078650802
L	078650803
XL	078650804
XXL	078650805
XXXL	078650806
XXXXL	078650807
5XL	078650808

7867G

~~£ 60,00~~ **£ 26,00**

Sleeveless work jacket

- Inserts made from "Oxford" polyester/PU, 220 g/m².
- Chest pockets with strap closure, pen pocket and badge insert
- Expanding waist pockets with zips and pullers

LIGHT

XS	078670800
S	078670801
M	078670802
L	078670803
XL	078670804
XXL	078670805
XXXL	078670806
XXXXL	078670807
5XL	078670808



7869G

~~£ 80,50~~ **£ 34,50**

Work jacket

- Inserts in "Oxford" polyester/PU, 220 g/m²
- Cuffs with strap adjusters
- Front strap closure with flap-covered double tap zip
- Adjustable waist
- Chest pockets with strap closure, pen pocket and badge insert
- Two deep waist pockets with strap closure

LIGHT

XS	078690800
S	078690801
M	078690802
L	078690803
XL	078690804
XXL	078690805
XXXL	078690806
XXXXL	078690807
5XL	078690808



7548M ~~£ 32,50~~ **£ 15,00**

*Modern print t-shirt,
100% cotton, 150 g/m², black*

NEW!



XS	075480400
S	075480404
M	075480401
L	075480402
XL	075480403
XXL	075480405
XXXL	075480406

7548C ~~£ 32,50~~ **£ 15,00**

*Classic print t-shirt,
100% cotton, 150 g/m², black*

NEW!



XS	075480500
S	075480501
M	075480502
L	075480503
XL	075480504
XXL	075480505
XXXL	075480506

9525TR ~~£ 24,30~~ **£ 12,00**

*Trucker cap with curved visor,
50% cotton, 50% polyester,
rear mesh, snapback style, black*

NEW!



9526F ~~£ 717,00~~ **£ 365,00**

*Mini fridge, energy efficiency
class F, capacity 63 l, black*

NEW!



9520P ~~£ 92,00~~ **£ 39,50**

*Umbrella stand,
made from galvanized metal,
with drip tray, black*

NEW!



9563U ~~£ 458,00~~ **£ 235,00**

Office armchair, ergonomic
Dimensions:
 • Back height: 97 cm
 • Seat dimensions: 50 cm x 53 cm
 • Overall chair height: 133-144 cm
 • Base: 35 cm (leg length)
 x 49 cm (height)



Beta

RSC 55



**MODULAR
SYSTEM**



**Configure
your workshop
in 3D online**



 **Beta**
AMBASSADOR

FABIO QUARTARARO



Partnership 2023

2023 MotoGP
World Championship



998016009

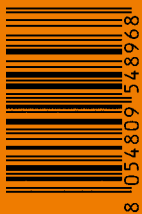

Beta Tools (UK) Limited | Unit D - Horton Enterprise Park
Hortonwood 50, Telford | Shropshire, TF1 7GZ
Sales: Tel. (01952) 677977

www.beta-tools.co.uk | sales@beta-tools.com