



Beta Action

2023



£

2023

Promotion

Valid from 01/09/2023 until 29/02/2024
Prices do not include V.A.T.

020010154 ~~£ 427.00~~ **£ 210.00**
2001/BZ24 MQ

Folding tool case with assortment of 24 tools, for electricians



≡ 380x290x60 mm



24

Quantity/Description	Beta N.
1 electrician's scissors, straight blades	1128BMX
1 combination pliers 1000V ≡ 180 mm	1150MQ
5 combination wrenches 8-10-13-17-19 mm	42
3 screwdrivers for headless slotted screws, 1000V ● 3x100 - 4x100 - 5,5x125 mm	1274MQ
3 screwdrivers for cross head Phillips® screws, 1000V ⊕ PH0x60 - PH1x80 - PH2x100 mm	1272MQ
9 ball head offset hexagon key wrenches burnished ○ 1,5-2-2,5-3-4-5-6-8-10 mm	96BP/SC9
1 mains testing screwdriver ●	1253
1 diagonal cutting nippers 1000V ≡ 160 mm	1082MQ

009100917 ~~£ 998.00~~ **£ 475.00**
910MQ/C16 **3/8"**

8 bi-hex sockets, 4 hexagon socket drivers and 4 accessories, insulated.



	910MQ/B	○ 8,10,11,12,13,14,17,19 mm
	910MQ/PE	○ 4-5-6-8 mm
	910MQ/21	125 mm
	910MQ/22	250 mm
	910MQ/55	
	910MQ/T	

009200917 ~~£ 1,195.00~~ **£ 550.00**
920MQ/C16 **1/2"**

9 hexagon sockets, 3 socket drivers for hexagon screws and 4 accessories, insulated.



	920MQ/A	○ 8-10-12 13-14-17 19-22-24 mm
	920MQ/PE	○ 5-6-8 mm
	920MQ/A21	135 mm
	920MQ/22	264 mm
	920MQ/55A	
	920MQ/T	

1000 V

012730606
1273MQ/D6
~~£ 100.00~~ **£ 48.00**



Set of 6 slim screwdrivers, insulated.

1274MQ/F 0,6x3,5x100-1x4,5x100-1x5,5x125-1,2x6,5x150 mm
 1272MQ/F PH1x4.5x80- PH2x6x100 mm



EN 60900

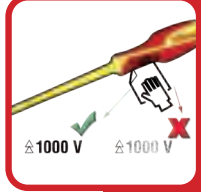
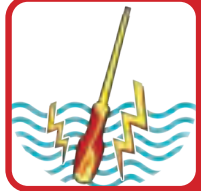

010480315
1048MQ
~~£ 85.50~~ **£ 41.00**



EN 60900

Slip joint pliers, boxed joint, insulated 1000V

• Chrome-plated finish

250 mm



011690143
1169MQ/D2
~~£ 131.00~~ **£ 66.00**



EN 60900

Assortment of insulated combination pliers and insulated diagonal cutting nippers



1082MQ 160 mm

1150MQ 180 mm

009140054
914MQ-A/S4
~~£ 85.50~~ **£ 43.00**



EN 60900

Set of hexagon hand sockets, 3/8" female drive, insulated.

made from special polyamide-based technopolymers

For use with torque wrench

mm	max (Nm)
8	6
10	9
13	20
17	30



3/8"

021030000 ~~£ 84.00~~ **£ 42.00**
C3

Mini tool bag, made from technical fabric

- 1 exterior front pocket with zip closure
- 2 side pockets with tote trays
- 1 convenient rear pocket with Velcro closure
- 1 removable interior tool panel, with elastic bands on both sides
- Complete with shoulder strap



890 g



230x110x320 mm

A MINI TOOL BAG TO ALWAYS BRING WITH YOU!



USB interface for charging mobile devices



021110000 ~~£ 108.00~~ **£ 54.00**
C11

Box, empty

- Hard water resistant plastic base
- Elastic tool bands and interior and exterior tool pockets
- Document holders built into double bottom of cover



2 kg

410x230x250 mm



021160000 ~~£ 147.50~~ **£ 74.00**
C16

Tool box, made of plastic, with interior object compartment, empty

- Double steel closure
- Aluminium folding handle running throughout length of cover
- Carrying capacity: 30 kg
- Increased functionality, reduced weight



2,5 kg

500x260x260 mm

Tool box, made of stainless steel and plastic, removable tote-tray, empty



021170500 ~~£ 116.50~~ **£ 58.00**
CP17

500x200x220 mm

2,5 kg

021170502 ~~£ 169.50~~ **£ 85.00**
CP17L

575x245x265 mm

3,7 kg

021050000
C5
£182.50 **£ 91.00**

Rucksack, empty

- Removable interior tool panel
- Six exterior pockets and two interior pockets
- Waterproof plastic base
- Double safety lace for fixing rucksack to shoulders
- Ergonomic padded back



400x200x500 mm

2,5 kg

021050100
C5S
£74.50 **£ 37.50**

Tool rucksack, made of hard-wearing polyester

- Double handle on top centre of rucksack for firm, balanced hold
- Two large front pockets
- Two capacious interior pockets
- 2 Velcro tool straps
- Handy roll-up interior bag, composed of 4 tool panels
- Adjustable reinforced shoulder straps
- Maximum carrying capacity: 15 kg



310x120x390 mm

900 g

TWO LARGE FRONT POCKETS

021060010
C6T
£271.00 **£ 136.00**

Rucksack with castors, empty

- Telescopic handle for easy transport
- Built-in castors with practical dustproof cover for use as a rucksack
- Two removable tool panels
- Interior PC pocket and five exterior pockets
- Waterproof plastic base



360x200x480 mm

4,5 kg

021080300
C8B
£278.00 **£ 139.00**

Tool trolley made from technical fabric, for electricians

- Hard frame
- Telescopic carrying handle
- 4 castors
- 1 removable interior tool panel
- Front pocket with badge holder
- Double bottom complete with tote tray
- 2 exterior side pockets
- 2 wire puller hooks
- Tilting handle for easier access to tools
- Can be padlocked (padlock not included)



IDEAL FOR ELECTRICIANS

4,7 kg

380x250x430 mm

Box, empty

- Hard frame
- Double bottom.
- Tilting handle for easier access to tools
- Elastic tool bands and interior and exterior pockets
- Cover
- Tool tray included in double bottom
- Can be used with trolley C8



(C10S - 420 mm) (C10 - 520 mm)

021100001
C10S
£142.50 **£ 71.00**
420x220x250 mm 2,3 kg

021100000
C10
£183.50 **£ 92.00**
520x220x250 mm 3,3 kg

C59A

"Endurance" workbench with 1 cab with 6 drawers



- 6 drawers (588x367 mm) with ball bearing slides:
 - 4 drawers, 70 mm high
 - 1 drawer, 140 mm high
 - 1 drawer, 280 mm high
- Worktop made from multiply wood with holes for vice item 1599F/125 (to be ordered separately)
- Drawers protected by foamed rubber mats
- Hard-wearing nylon drawer front
- Roller cabs can accommodate thermoformed trays
- Front centralized safety lock
- Lower object shelf
- Can be fitted with paper roll holder (2400 RSC24/PC) and bottle holder (2400 RSC24/PF-), to be ordered separately.



Ral 2011	Ral 7016	Ral 3000
059000011	059000031	059000051

£2,065.00 ~~£ 1,030.00~~

n°	mm	Max
4	70 mm	25 kg
1	140 mm	30 kg
1	280 mm	35 kg

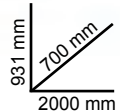

RSC51

Service tool trolley with 3 drawers

- 3 drawers (588x367 mm) with ball bearing slides, 70 mm high
- ABS reinforced worktop, solid and sturdy
- Multipurpose top with anti-fall edges and 8 holes for accommodating screwdrivers
- Drawer bases protected by foamed rubber mats
- Each drawer can accommodate up to 4 EVA foam or ABS thermoformed trays
- Front centralized safety lock
- Convenient side screwdriver holder included
- Two built-in side spray can holders
- Large lower shelf protected by an anti-oil and anti-petrol rubber mat
- 4 castors, Ø 125 mm: 2 fixed castors and 2 swivel castors (one with brake)
- Static load capacity: 400 kg
- Capacity of each drawer: 15 kg, evenly distributed



n°	mm	Max
3	70 mm	15 kg



CUSTOMIZABLE WITH MULTIPLE AVAILABLE ACCESSORIES

- Following accessories can be added:
- Wood worktop 2400 RSC24/PL
 - Perforated tool panel 2400 RSC24/PF
 - PC support 2400 RSC24/SPC
 - Folding shelf 2400 RSC24/MP
 - Paper roll holder 2400 RSC24/PC-A

Ral 2011	Ral 3000	Ral 7016
051000300	051000303	051000307

£685.00 ~~£ 345.00~~

C58P

Wall mounted lockable tool storage

- Security locked shutter made of painted aluminium.
- Two removable perforated panels for tool holding.

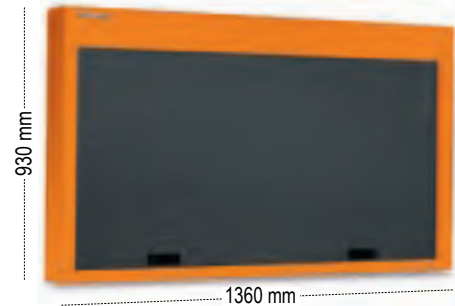

Ral 2011	Ral 7016	Ral 3000
058000221	058000222	058000223



£1,118.00 ~~£ 560.00~~

1599GI

Parallel bench vices with interchangeable jaws

- With square guide for heavy-duty jobs
- Interchangeable jaws with hardened surface

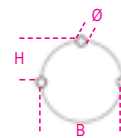

	L1 mm	BxH mm	Ø mm	A max mm		£
1599GI 100	100	92x46	11	125	015990200	£ 450.00 £ 225.00
1599GI 125	125	108x54	13	150	015990225	£ 601.00 £ 300.00
1599GI 150	150	125x62	13	200	015990250	£ 817.00 £ 410.00
1599GI 175	175	140x70	15	220	015990275	£ 1,074.00 £ 535.00

RSC23

Portable tool chest with 5 drawers

Main features:

- 5 drawers (588x277 mm) with ball bearing slides:
 - 2 drawers, 50 mm high
 - 3 drawers, 70 mm high.
- Front centralized lock.
- Retractable side handles for ease of handling.

~~£ 750.00~~ **£ 375.00**



Ral 2011	Ral 7016	Ral 3000
Ral 7016	Ral 7016	Ral 7016
023003001	023003007	023003003

n°	Max
3 70 mm	25 kg
2 50 mm	25 kg

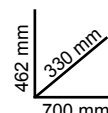

25 kg

RSC23T

Portable tool chest with 5 drawers

Main features:

- 5 drawers (588x367 mm) with ball bearing slides:
 - 5 drawers, 70 mm high.
- Front centralized lock.
- Can be fitted with kit of 4 castors and 1 handle (2300ST/KIT)

~~£ 883.00~~ **£ 442.00**



RSC23T-FO	RSC23T-O	RSC23T-G	RSC23T-R	RSC23T-B	RSC23T-A	RSC23T-N
Ral 2011	Ral 2011	Ral 9006	Ral 3000	Ral 5015	Ral 7016	Ral 9005
023003020	023003021	023003022	023003023	023003026	023003027	023003029

n°	Max
5 70 mm	25 kg



36 kg

023000950

2300ST/KIT

~~£ 238.00~~ **£ 119.00**

kit with 4 castors and 1 handle for RSC23T

- Four castors, Ø 125 mm:
 - 2 fixed and 2 steering (one with brake).
- Telescopic handle



6,5 kg

023000610

CD23S

~~£ 330.00~~ **£ 165.00**

Caddy trolley

Main features:

- ABS-coated worktop designed to match tool chests RSC22, RSC23, RSC23C, RSC23T
- Removable handle, can be stored underneath chassis.
- Four castors, Ø 100 mm: 2 fixed and 2 steering (one with brake).
- Maximum load capacity: 250 kg.



14 kg

The evolution of perfection! Discover the RSC range!

The RSC range has been designed to satisfy all professionals' requirements and ensure reliability as well as high operation performance. The innovative design, inspired by the racing world, provides these mobile roller cabs and trolleys with a captivating, unique style: the 7 colours and its finish make the RSC range synonymous with one-of-a-kind products in the market. The sturdy frameworks and the materials result in high quality and remarkable durability, thereby effectively supporting the daily work of industrial production departments, mechanics, car body repairers and general maintenance service providers. What is more, most RSC roller cabs are TÜV certified. This prestigious certification - which is the name for safety and guaranteed quality - is obtained upon successful completion of severe tests under the EK5/TA5 protocol.



* Tools not included

RSC24

Mobile Roller cab

- Multi-purpose top with anti-fall edges and eight holes for accommodating screwdrivers
- Drawer bases protected by foamed rubber mats
- Four castors Ø 125 mm: 2 fixed and 2 steering (one with brake)
- Each drawer can accommodate up to 4 EVA foam or ABS thermoformed trays
- Front centralized safety lock.
- Static load capacity: 800 kg.
- Built-in bottle holder (can be applied on both sides).

The following accessories can be added:

- Wood worktop 2400 RSC24/PL
- Perforated tool panel 2400 RSC24/PF
- Folding shelf 2400 RSC24/MP
- Document holder 2400 RSC24//D
- Paper roll holder 2400 RSC24/PC
- Computer wall bracket 2400 RSC24/SPC

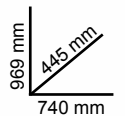

	Ral 2011	Ral 2011	Ral 9006	Ral 3000	Ral 5015	Ral 7016	Ral 9005	kg	£
		Ral 7016	Ral 7016	Ral 7016	Ral 7016	Ral 7016			
RSC24/5	024004050	024004051	024004052	024004053	024004056	024004057	024004059	60	£ 1,181.00 £ 590.00
RSC24/6	024004060	024004061	024004062	024004063	024004066	024004067	024004069	62	£ 1,285.00 £ 605.00
RSC24/7	024004070	024004071	024004072	024004073	024004076	024004077	024004079	63	£ 1,235.00 £ 620.00
RSC24/8	024004080	024004081	024004082	024004083	024004086	024004087	024004089	66	£ 1,295.00 £ 650.00

RSC24/5		
n°	Max	kg
2	70 mm	25 kg
2	140 mm	30 kg
1	280 mm	35 kg

RSC24/6		
n°	Max	kg
4	70 mm	25 kg
1	140 mm	30 kg
1	280 mm	35 kg

RSC24/7		
n°	Max	kg
5	70 mm	25 kg
1	140 mm	30 kg
1	210 mm	30 kg

RSC24/8		
n°	Max	kg
6	70 mm	25 kg
2	140 mm	30 kg



024500005 ~~£ 256.00~~ **£ 128.00**

M05

16



42 6-7-8-9-10-11-12-13-14-15-16-17
18-19-20-21 mm

1,5 kg

024500091 ~~£ 273.00~~ **£ 135.00** **1/4"**

M91

25



- 900 4-4,5-5-5,5-6-7-8-9-10-11-12-13-14 mm
- 900ME 2,5-3-4-5-6-8 mm
- 900/20 50 mm
- 900/21 150 mm
- 900/25 □ 1/4 - ■ 1/4
- 900BG/30
- 900/42
- ⊗ 900/55

560 g



024500096 ~~£ 430.00~~ **£ 215.00** **1/2"**

M96

22



- 920A/AS 3/8-7/16-1/2-9/16-19/32-5/8-11/16-3/4-25/32-13/16-7/8-15/16-1-1.1/16-1.1/18-1.3/16-1.1/4
- 920/25
- 920AN 125-250mm
- 920/42
- ⊗ 920/55

3,8 kg

024500092 ~~£ 342.00~~ **£ 170.00** **3/8"**

M92

22



- 910A 6-7-8-9-10-11-12-13-14-15-16-17-18-19-20-21-22 mm
- 910/21 125 mm
- 910/22 250 mm
- 910/25
- 910/42
- ⊗ 910/55

1,5 kg

024500133 ~~£ 101.50~~ **£ 50.00**

M133

3



- ⌘ 1082G 160 mm
- ⌘ 1150G 180 mm
- ⌘ 1166G 160 mm

650 kg

024500213 ~~£ 224.50~~ **£ 112.00**

M213

25

NEW

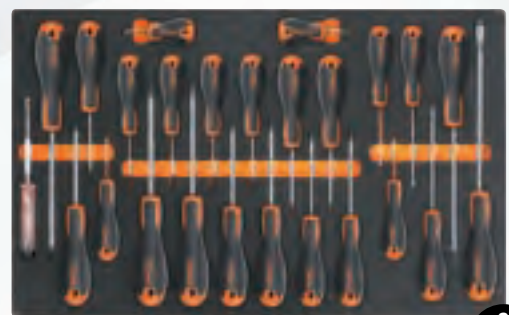

1,8 kg

- 1201E 2,5x50-3x75-4x100-5,5x125-6,5x150-8x200 mm
- 1201EN 4x30 mm
- 1202E PH0x60-PH1x80-PH2x100-PH3x150 mm
- 1202EN PH1x30 mm
- 1207E/TX T6-T7-T8-T9-T10-T15-T20-T25-T27-T30-T40-T45
- 1253

C45PRO RD

Fixed sorted waste collection module for workshop equipment combination C45PRO

The ideal solution for sorted waste collection (glass, paper, plastic...)

- Sturdy sheet metal frame complete with 4 containers with up-and-over door for sorting waste
- Each container is fitted with:
 - one removable plastic bin; capacity: 25 l, 4 swivel castors, Ø 60 mm
- Supplied with kit of 4 coloured adhesive tapes
- With vertically adjustable feet



C45PRO RD/X



C45PRO RD/W



045000241

C45PRO RD/X



£ 2,160.00 **£ 1,080.00**

045000240

C45PRO RD/W



£ 2,020.00 **£ 1,010.00**

C45PRO M7A

Fixed module with 7 drawers, for workshop equipment combination C45PRO

- 1 drawer (1248x406 mm) with ball bearing slides
- 6 drawers (782x406 mm) with ball bearing slides:
 - 5 drawers, 65 mm high
 - 1 drawer, 145 mm high
- Drawer bases protected by foamed rubber mats
- Front centralized lock
- With vertically adjustable feet
- Can be fitted with thermoformed trays
- 1 storage compartment with intermediate shelf and door, interior dimensions 504x424x597 mm



045000161

C45PRO M7A/X



£ 1,950.00 **£ 975.00**

- **Stainless steel coated MDF worktop, 1360 mm long**



045000171

C45PRO M7A/W



£ 1,830.00 **£ 915.00**

- **Multi-ply wood worktop, 1360 mm long**

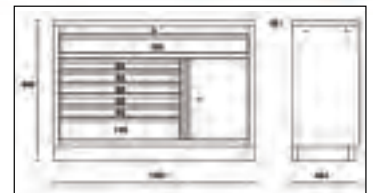

C45PRO MWS

Work Station roller cab with 7 drawers and built-in waste bin

- 1 drawer (1248x406 mm) with ball bearing slides
- 6 drawers (782x406 mm) with ball bearing slides:
 - 5 drawers, 65 mm high
 - 1 drawer, 145 mm high
- Drawer bases protected by foamed rubber mats
- Can be fitted with thermoformed trays
- Storage compartment with intermediate shelf and door, interior dimensions 504x424x597mm
- Built-in waste bin
- Built-in paper roll support
- 4 heavy-duty castors, Ø 150 mm, 2 fixed and 1 steering brake
- Front centralized lock



h	max
65 mm	25 kg
105 mm	40 kg
145 mm	30 kg

045000181

C45PRO MWS/X



£ 2,200.00 **£ 1,100.00**

- **Worktop (1680 mm) made of stainless steel coated MDF**

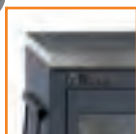

045000191

C45PRO MWS/W



£ 2,150.00 **£ 1,080.00**

- **Multi-ply wood worktop (1680 mm)**

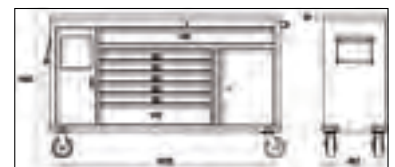

009510687
951/S6 ~~£ 165.50~~ **£ 83.00**

Set of 6 T-handle wrenches with three hexagon male ends

○ 2,5-3-4-5-6-8

2,5÷6 mm



951

The Original One

When this wrench was launched, back in 1980, it was a revolution. Designed to work on high-resistance screws, it is the name for quick handling, accurate fit and flexible use. The hexagon T handle can be adjusted as required. The hexagon ends are designed to transmit the maximum possible torque to the screw. The rod length allows remarkable torques to be effortlessly applied to the screws. Ongoing production improvements have translated, for example, into sandblasted finishes and sharp-edged hexagon ends which allow a better fit onto any screws, including damaged ones. Laser marking results in a sturdier rod.

COLOR CODE

IDENTIFY YOUR SIZE IMMEDIATELY!

000961619
96BP-CL/SC9 ~~£ 47.00~~ **£ 23.50**

Set of 9 ball head offset key wrenches, coloured

Ø mm	L mm
1,5	91
2	102
2,5	113
3	128
4	143
5	163
6	185
8	206
10	231

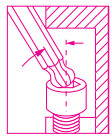

EXTRA LONG VERSION +30%



000971658
97BTX-C/SC8 ~~£ 82.00~~ **£ 41.00**

Set of 8 coloured ball head offset key wrenches, for Torx® head screws

Ø mm	L mm
T9	80
T10	86
T15	90
T20	95
T25	100
T27	105
T30	114
T40	124

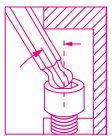

001422087
142MC/SC9I ~~£ 281.00~~ **£ 141.00**

Set of 9 reversible ratcheting combination wrenches, coloured, with compact support

Ø mm	L mm
8x8	136
10x10	159
11x11	168
12x12	174
13x13	180
14x14	190
15x15	200
17x17	233
19x19	248



111E

Head angled at 15°, allowing hardly accessible spaces to be reached, as is the case with our iconic combination wrenches, "42"

THE NEW ADJUSTABLE WRENCHES WITH SCALES, BETA 111E allow differently sized nuts and bolts to be tightened and loosened through the sliding jaws, which can be adjusted through the central rolls.

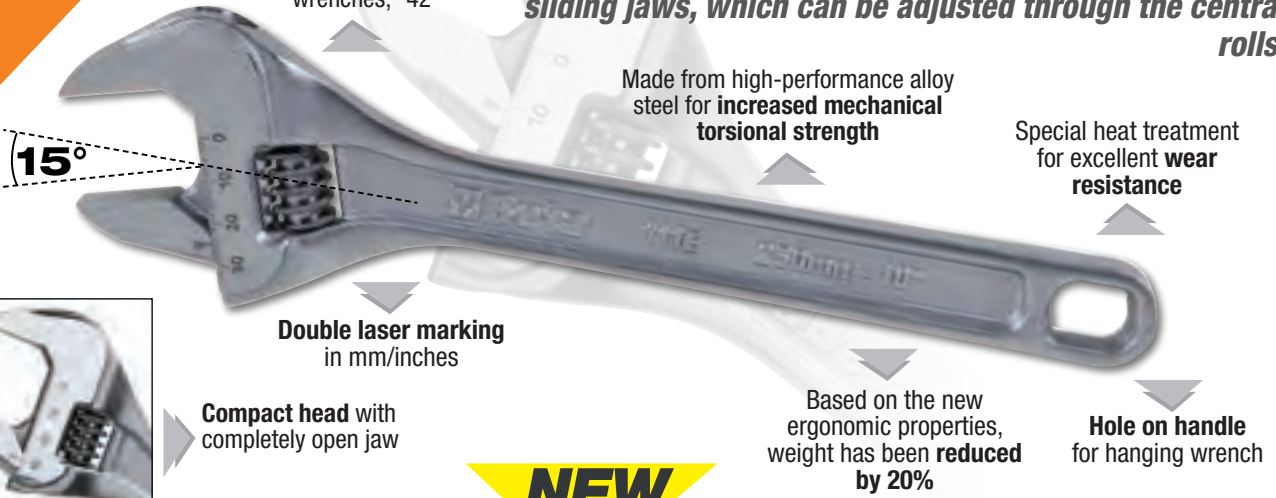

NEW

111E

Adjustable wrenches with scales, **chrome-plated**
• right-hand rotation of pin



	L mm	L "	A max mm		£
111E 100	100	4	15	001110110	£ 25.00 £ 12.50
111E 150	150	6	24	001110115	£ 26.00 £ 13.00
111E 200	200	8	29	001110120	£ 33.50 £ 17.00
111E 250	250	10	34	001110125	£ 42.50 £ 21.50
111E 300	300	12	40	001110130	£ 53.50 £ 27.00
111E 380	380	15	45	001110138	£ 111.00 £ 56.00
111E 450	450	18	54	001110145	£ 187.00 £ 94.00
111E 600	600	24	62	001110160	£ 256.00 £ 128.00

111EN

Adjustable wrenches with scales, **phosphated**
• left-hand rotation of pin



	L mm	L "	A max mm		£
111EN 100	100	4	15	001110410	£ 24.50 £ 12.50
111EN 150	150	6	24	001110415	£ 25.00 £ 12.50
111EN 200	200	8	29	001110420	£ 32.00 £ 16.00
111EN 250	250	10	34	001110425	£ 39.00 £ 19.50
111EN 300	300	12	40	001110430	£ 51.00 £ 25.50
111EN 380	380	15	45	001110438	£ 108.00 £ 54.00
111EN 450	450	18	54	001110445	£ 184.00 £ 92.00

111ER

Reversible jaw adjustable wrenches with scales, **chrome-plated**
• right-hand rotation of pin



	L mm	L "	A max mm	Ø max mm		£
111ER 200	200	8	29	3/4	001110520	£ 41.50 £ 21.00
111ER 250	250	10	34	1	001110525	£ 51.00 £ 25.50
111ER 300	300	12	40	1.1/4	001110530	£ 82.00 £ 41.00

111CM

Wide opening adjustable wrenches, **chrome-plated**, short series
• right-hand rotation of pin



	L mm	L "	A max mm		£
111CM 170	170	6	32	001110770	£ 49.00 £ 24.50
111CM 220	220	8	38	001110722	£ 68.00 £ 30.00
111CM 270	270	10	46	001110727	£ 78.00 £ 39.00

NEW

012100701

1210E/GE

~~£ 187.00~~

£ 94.00

Evox-E electric screwdriver



BITS INCLUDED:



Technical data:

- 3.7V 2300mAh lithium battery
- Maximum torque in electric mode: 1.2 Nm
- **Over 1,000 screw fastenings at 1.2 Nm per charging cycle**
- **Speed: 250 rpm**
- **Outstanding static resistance (up to 12 Nm, manual tightening)**
- Outstanding mechanical resistance
- 1/4" magnetic bit holder
- Compatible with all standardized bits
- Rechargeable via USB-C cable (included)
- USB-C port protected with screw cap
- Front ring LEDs for improved visibility of working area
- When charging, steady LEDs indicate that charging is complete
- Ergonomic nylon handle inspired by Evox screwdriver
- Built-in and sealed operation buttons
- Convenient belt pouch with bit pockets (6 mixed bits included)

Beta **EVOX-E**

012630007

1263/D7PZ

~~£ 83.00~~

£ 40.00

Set of 7 screwdrivers

1260 ● 0,5x3x75-0,8x4x100-1x5,5x150-1,2x6,5x150mm
1269PZ ● PZ0 - PZ1 - PZ2



012430017

1243/D7

~~£ 128.50~~

£ 62.00

Steel capped hammer through screwdriver set

1241 ● 1x5,5x100-1,2x6,5x125
1,2x8x150-1,6x10x200 mm
1242 ● PH1x4,5x100-PH2x6x100
PH3x8x150 mm



012670307

1267TX/D7

~~£ 84.50~~

£ 41.00

Set of 7 screwdrivers

1267TX ● T6-T8-T10-T15-T20-T25-T30

Beta
GRIP



008600880 **860/C27** £109.50 **£ 55.00** 1/4"

25 bits, 1 connector and 1 reversible ratchet in plastic case



- 860LP 0,5x3-1,0x5,5-1,2x6,5 mm
- 860PE 2-2,5-3-4-5-6-mm
- ⊕ 860PH PH1-PH2(x2)-PH3
- ⊗ 860TX T6-T8-T10-T15-T20-T25-T30-T40
- ⊕ 860PZ PZ1 - PZ2(2x) - PZ3
- 860/55 100 mm
- 892/0

009000947 **900/C39N** £248.50 **£ 125.00** 1/4" 1/4"

Assortment of 11 hexagon sockets, 21 bits and 7 accessories, in plastic case



150x97x53 mm

	900		5-5,5-6-7-8-9-10-11-12-13-14 mm	11
	900/20		50 mm	1
	900/20L		100 mm	1
	900/25			1
	900BG/30C		128 mm	1
	892/0		■ 1/4 - ● 1/4	1
	895/1		○ 1/4 - □ 1/4	1
	861LP		● 0,6x4,5-1,2x6,5-1,2x8 mm	3
	861PH		⊕ PH1-PH2-PH3	3
	861PZ		⊕ PZ1-PZ2-PZ3	3
	861PE		○ 2,5-3-4-5-6 mm	5
	861RTX		⊗ T10-T15-T20-T25-T27-T30-T40	7
	900/55Z		126 mm	1

009001947 **900/C39U** £258.00 **£ 120.00** 1/4" 1/4"

Assortment of 11 gear lock sockets, 21 bits and 7 accessories, in plastic case



150x97x53 mm

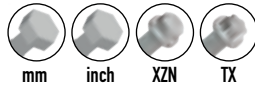

	900U		mm 5-5,5-6-7-8-9-10-11-12-13-14 mm " 3/16-13/64-7/32-1/4-9/32-5/16-11/32-3/8-7/16-15/32-1/2-9/16 XZN M6-M8-M10-M12-M14-M16-M18 TX E6-E7-E8-E10-E12-E14-E16-E18	11
	900/20		50 mm	1
	900/20L		100 mm	1
	900/25			1
	900BG/30C		128 mm	1
	892/0		■ 1/4 - ● 1/4	1
	895/1		○ 1/4 - □ 1/4	1
	861LP		● 0,6x4,5-1,2x6,5-1,2x8 mm	3
	861PH		⊕ PH1-PH2-PH3	3
	861PZ		⊕ PZ1-PZ2-PZ3	3
	861PE		○ 2,5-3-4-5-6 mm	5
	861RTX		⊗ T10-T15-T20-T25-T27-T30-T40	7
	900/55Z		126 mm	1

009100909 **910A/C10** £228.00 **£ 110.00** 3/8"

10 sockets and 2 accessories



270x120x45 mm

	910A		○ 6-7-8-10-11-12-13-14-17-19 mm	
	910/21		125 mm	
	910/55			

1,3 kg

009100936
910A/C16 ~~£ 347.00~~ **£ 175.00**

Assortment of 16 hexagon sockets and 5 accessories, in metal case

3/8"

21x

	910A	○	6-7-8-9-10-11-12-13-14-15-16-17-18-19-21-22 mm
	910/21		125 mm
	910/22		250 mm
	910/25		
	910/42		210 mm

≡ 335x145x60 mm

Reversible ratchet (910/55)



009200933
920A/C12X ~~£ 357.00~~ **£ 180.00**

Assortment of 12 sockets and 5 accessories

1/2"

	920A	○	10-11-12-13-14-17-19-22-24-27-30-32 mm
	920/21		125 mm
	920/22		255 mm
	920/25		
	920/42		
	920/55	⊗	

4,2 kg

≡ 420x185x60 mm



009200950
920A/C20X ~~£ 433.00~~ **£ 215.00**

20 sockets and 5 accessories

1/2"

	920A	○	10-11-12-13-14-15-16-17-18-19-20-21-22-23-24-26-27-28-30-32 mm
	920/21		125 mm
	920/22		255 mm
	920/25		
	920/42		
	920/55	⊗	

5,1 kg

≡ 420x185x60 mm



009280955
928A/C12 ~~£ 978.00~~ **£ 485.00** **3/4"**

Assortment of 12 hexagon hand sockets and 5 accessories, in metal case

13,5 kg

≡ 530x220x80 mm

	928A	○	22-24-27-30-32-34-36-38-41-46-50-55 mm
	928/21		200 mm
	928/22		380 mm
	928/25		
	928/42		450 mm
	928/55	⊗	

17x



CE **665** **3/8" 1/2"**

QUICK, ACCURATE DIGITAL TORQUE ADJUSTMENT

UNI EN 26789 ISO 6789

Mechanical torque wrench with digital setting and reversible ratchet, for right-hand tightening, torque accuracy ± 3%

- Auto power off after 10" when torque is set under minimum torque threshold
- Display will remain on with set torque value
- Torque setting to decimal digit
- Power supply: 1 battery 3V (included)



	Nm mm	■	D (mm)	A (mm)	L (mm)	g	■	£
665/6	10÷60	3/8	30	33	335	655	006650006	£ 311.00 £ 156,00
665/10	20÷100	3/8	30	33	375	725	006650010	£ 328.00 £ 160.00
665/20	40÷200	1/2	40	43	470	995	006650020	£ 351.00 £ 176.00
665/30	60÷330	1/2	40	43	590	1260	006650030	£ 489.00 £ 205.00

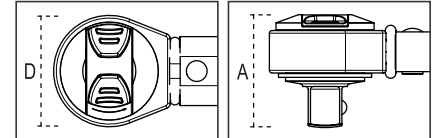

005610010 **561/1** ~~£1,765.00~~ **£ 885.00**

Torque multiplier for right-hand and left-hand tightening, ratio 5:1, with two reaction feet

- Supplied with straight lever and 90° foot
- Ideal for use in small areas (body Ø 65 mm)
- Ultralightweight (1.5 kg)
- Measuring range: 100÷1000 Nm
- Female drive: 1/2"
- Male drive outlet: 3/4"
- For right-hand and left-hand tightening
- Torque accuracy: ± 4%

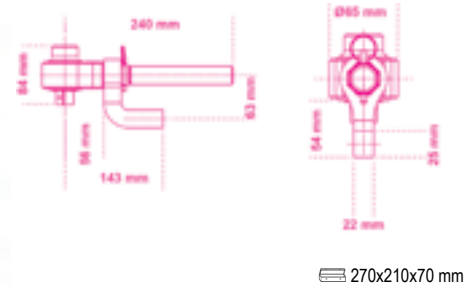

Nm	kgfm	lbf.ft	□	■	g
1000	100	740	1/2	3/4	2,7

010310000 **1031/S4** ~~£ 124.00~~ **£ 62.00**

Set of 4 circlip pliers

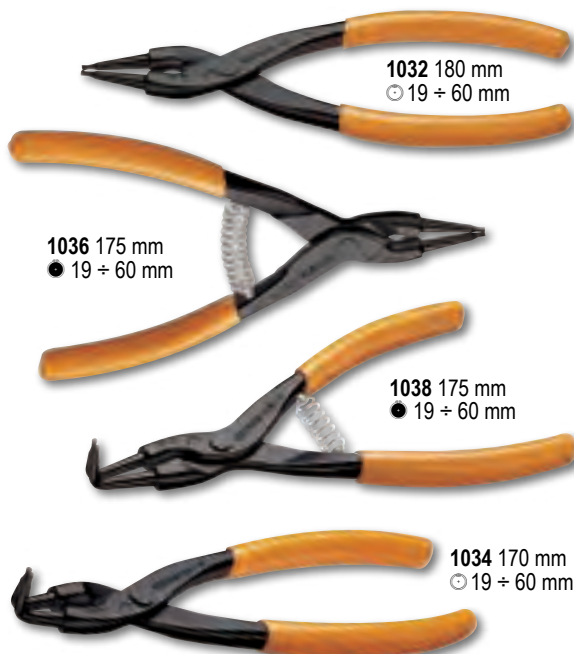

011690273 **1169GBM/D3** ~~£ 113.50~~ **£ 57.00**

Set of 3 includes 1x combination pliers, 1x long nose needle pliers and 1x diagonal cutting nippers, bi-material handles, industrial finish.



Poligrip pliers, boxed joints OUTSTANDING GRIP AND AMAZING HANDLING

010480923

1048N/D3

~~£ 143.00~~ **£ 72.00**

Set of 3 slip joint pliers

Main features:

- Triangular section grip for a more comfortable contact surface
- Tapered head allowing access to small spaces
- Case-hardened nail for improved wear resistance
- Phosphated finish
- Made from chrome-vanadium steel



1048VN

Slip joint pliers, boxed joints,
with orange lacquered finish



	L mm	A Max mm	L1 mm	S mm	g		£
1048VN 175	175	36	31	11	189	010480111	£ 32.00 £ 16.00
1048VN 250	250	46	38	13	354	010480116	£ 34.50 £ 17.00
1048VN 300	300	60	44	14,8	554	010480121	£ 55.00 £ 28.00

018380400

1838AM

~~£ 143.00~~ **£ 72.00**

Rechargeable LED inspection lamp, with
double light emission, articulated, can be
rotated 180°, with swivel magnetic base
and hook

• double light emission:

- front: LED COB, 60-700 lumens, can be adjusted with potentiometer spot (head): LED SMD, 120 lumens, ON-OFF switch
- rechargeable 3.6V 2600mAh Li-ion battery
- with USB-C port
- supplied with 100-240V / 50-60Hz charger
- charging time: 4h
- battery life: front: 2.5-16h
spot (head): 10h
- 3-LED battery level indicator
- articulated, can be rotated 180° (± 90° compared to axis)
- magnetic base (with neodymium magnet), can be rotated 90°
- swivel base hook

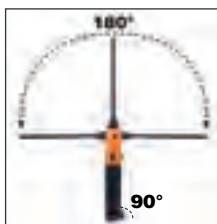

L 405 mm



4 h



2,5-16h
Spot: 10h



405x40x45 mm



IP54



018360051

1836AW

~~£ 72.00~~ **£ 36.00**

Rechargeable wireless
LED headlamp, dual brightness

- **Dual light emission:** front: 3 light intensities, LED COB, 30 - 200 - 400 lumens head (spotlight): LED COB, 400 lumens
- Rechargeable battery: Li-ion 3.7 V, 1500 mAh, 5.55 Wh
- USB-C port
- Supplied with USB-C cable
- Charging time: 2.5 h
- Battery life: front: 4-18 h
head (spotlight): 4 h
- IP 65
- IK 07



WIRELESS RECHARGEABLE



Front: 30/200/
400 lumen
Spot: 400 lumen



Front: COB LED
Spot: COB LED



2,5 h



Wireless
charging



4-18h
Spot: 4h



Li-ion 3.7V
1500mAh 5.55Wh



70x52x45 mm



IP65



WIRELESS RECHARGEABLE

018380080

1838POCKET

£ 92.50

£ 46.50

NEW

Articulated pocket LED spotlight, with dual light beam and wireless charging

- Rechargeable 3.7V 2600mAh Li-ion battery
- 2 charging modes:
 - wireless 1839BRW base
 - power supply with USB-C port
- Charging time:
 - 4.5 h with wireless charging base
 - 4 h with power supply
- Battery life: - main light: 3-9h
- spot light: 4.5 h
- 3-LED battery level indicator
- Can be rotated 210°
- Nonslip rubber body
- Magnetic base
- 1 magnet on base
- IP65
- IK07
- Supplied with a USB-C cable



- **Dual light emission:**
 - main light: LED COB, 3 light intensities: 160 - 400 - 800 lumens
 - spot light: LED SMD, 250 lumens
- **Lighting angle:**
 - main light: 160°
 - spot light: 18°



Front: 160/400/800 lumen
Spot: 250 lumen



Front: COB LED
Spot: SMD LED



4 h



Wireless: 4.5h



3-9h
Spot: 4.5h



3.7V 2600mAh Li-ion



98x82x39 mm



-10°C + 40°C



wireless charger base NOT included



018390002

1839BRW

£ 136.50

£ 68.00

NEW

Wireless charging base, compatible with 1838POCKET, 1838SW inspection lamps

- Two charging positions with magnetic connection, for simultaneous use
- With pull-out support for wireless mobile phone charging
- Charging status LED indicator
- Max. input: 10W x2
- Input: AC 100-240V 50/60Hz
- Output: DC 12V 1.5A
DC 9V 2A
DC 5V 3A
- USB-C port
- IP20
- IK07



Input 10W x2



QC 3.0 USB-C



3-9h



101x190x28 mm



- Can be hung on wall through: 3 strong magnets on back
2 screw holes



018380142

1838SW

£ 138.50

£ 69.00

Rechargeable, articulated LED inspection lamp, with wireless charger

- Rechargeable 3.6V 3.350mAh Li-ion battery
- 2 charging modes:
 - wireless 1839BRW base
 - power supply with USB-C port
- Charging time:
 - 6.5h with wireless charging base
 - 4.5h with power supply
- Battery life: - front: 1.3-5H
- spot (head): 7h
- 3-LED battery level indicator
- Base can be rotated 180°
- Nonslip rubber body
- Double swinging hook
- Magnets on base and back
- IP65
- IK07



- **Dual light emission:**
 - front: LED COB, 3 light intensities: 250 - 500 - 1000 lumens
 - spot (head): LED SMD, 200 lumens



Front: 250/500/1000 lumen
Spot: 200 lumen



Front: COB LED
Spot: SMD LED



4.5 h



Wireless: 6.5h



3-5h
Spot: 7h



3.6V 3.350mAh Li-ion



260x53x40 mm



-10°C + 40°C

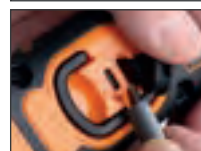
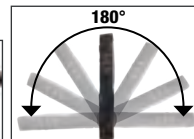

wireless charger base NOT included

1778MT



BETA's multipurpose tool

stands out from similar commercially available tools with BETA's typical hallmarks: pliers synonymous with matchless quality, sophisticated materials and state-of-the-art technology. The 11 bits, which come in the most popular geometries in the market, make this item ideal for any work environments and conditions, e.g. camping, nautical industry, hunting and DIY.



Easy pull-out of tools



Tool unlock buttons

SUITABLE FOR EVERY SITUATION!

COMPACT AND VERSATILE!

DESIGNED FOR EVERY NEED!

9 tools for a total of 22 functions:

- Combination pliers
- Large blade
- Corrugated blade
- Hacksaw frame
- File
- Tin/Bottle opener
- Scissors
- Bit holder
- Screwdriver for cross head Phillips® screws



11 bits + socket + tweezers



Ruler 100 mm + Ruler, 4"

017780055
1778MT

~~£ 126.50~~

£ 63.00

Multi-tools complete with bits and sheath



NEW

017770030
1777T

~~£ 32.00~~ **£ 15.00**

Foldaway knife with trapezoidal blade, aluminium handle
5 spare blades

- Stainless steel frame
- With blade locking button
- Handle made from anodized aluminium, orange



017780026
1778AX

~~£ 56.00~~ **£ 27.00**

Foldaway knife, stainless steel serrated blade, aluminium handle, serration pattern for easier opening in case



017780080
1778S0S

~~£ 39.50~~ **£ 20.00**

Car service knife with window breaking hammer and seat belt cutter features, in case

- With clip and fabric wallet with loop
- Anodized aluminium handle
- Safety blade lock

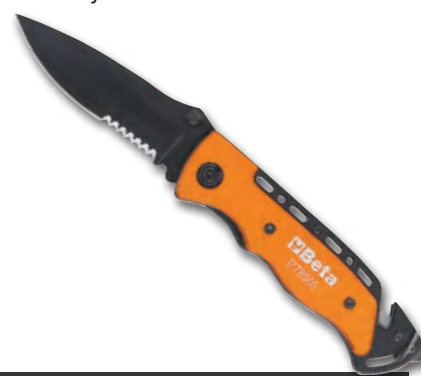

004120419
412/SP19
 £ 127.00 £ 62.00

Set of 19 twist drills with cylindrical shanks, HSS, AISI M2, entirely ground finishing

HSS

Ø 1÷10 X 0,5 mm



004150425
415/SP25
 £ 519.00 £ 255.00

Set of 25 twist drills with cylindrical shanks in case

HSS COBALT / CO8%

Ø 1÷13 X 0,5 mm



004240019
424/SP3
 £ 247.00 £ 120.00

Set of conical drill bits in case

HSS

Ø 3÷30 MM



004250030
425/SP3
 £ 407.00 £ 200.00

Set of 3 stepped drills HSS

Ø 4÷30 mm



450 g

004460055
446/C30
 £ 433.00 £ 210.00

Assortment of chrome-steel taps and dies, metric thread, and accessories in wooden case



325x220x35 mm

3,2 kg

430 M mm	440 M mm		
3x0,5	3x0,5	435/1,5	444/1
4x0,7	4x0,7		
5x0,8	5x0,8		
6x1	6x1		
8x1,25	8x1,25		
10x1,5	10x1,5		
12x1,75	12x1,75		

004460057
446/C48
~~£ 876.00~~ **£ 430.00**

Assortment of chrome-steel taps and dies, metric thread, and accessories in wooden case



580x300x50 mm **5 kg**

430 M mm	440 M mm	440A M mm		
3x0,5	3x0,5	10x1,5	435/1	444/1
4x0,7	4x0,7	12x1,75	435/3	444/2
5x0,8	5x0,8	14x2		
6x1	6x1	16x2		
8x1,25	8x1,25	18x2,5		
10x1,5		20x2,5		
12x1,75				
14x2				
16x2				
18x2,5				
20x2,5				

004500315
450/C21
~~£ 1,031.00~~ **£ 495.00**

Assortment of holesaws and accessories for industrial use



HSS-Co 8% **7 kg**
 420x280x60 mm

450 Ø 19 - 22 - 29 - 35 - 38
 44 - 51 - 57 - 64 - 76
 83 - 92 - 95 - 105 - 114 mm

450AL /1 - /2
450PA /1 - /2
450PR
450AD

1500N

Universal pullers with 2 sliding legs

- Special leg design, for automatic leg locking under loading conditions.
- For both external and internal use
- Legs can be moved along crosspiece.

	A min+Max mm	L mm	L1 mm	● mm	A1 mm	📦	£
1500N/0	18÷65	70	100	15	110	015000600	£ 87.00 £ 44.00
1500N/1	23÷70	100	130	17	130	015000601	£ 88.00 £ 44.00
1500N/2	23÷100	100	130	17	160	015000602	£ 90.00 £ 45.00
1500N/3	35÷140	150	190	20	230	015000603	£ 152.50 £ 76.00
1500N/4	35÷190	150	190	20	280	015000604	£ 163.00 £ 82.00
1500N/5	43÷250	205	295	27	360	015000605	£ 323.00 £ 160.00
1500N/6	43÷320	205	295	27	430	015000606	£ 344.00 £ 170.00

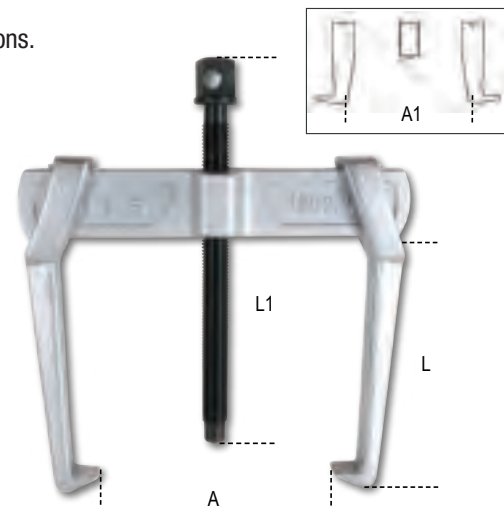

1517

Three-leg self-locking pullers

Simultaneous leg opening,
 Self-locking effect, Double nut, Patent pending

	Max kg	A min+Max	○ mm	● mm	📦	£
1517/90	6000	18÷90 mm	22	19	015170000	£ 341.00 £ 170.00
1517/150	6000	25÷150 mm	22	19	015170010	£ 363.00 £ 180.00
1517/200	6000	40÷200 mm	22	19	015170020	£ 407.00 £ 205.00
1517/260	8000	50÷260 mm	30	27	015170030	£ 458.00 £ 230.00



AUTOMOTIVE



Electronic car / commercial vehicle battery charger

IP65

- Protected against polarity reversal and short circuits
- Digital backlit display
- Pull-back fixing hook

014980104 ~~£ 224.50~~ **£ 112.00**

1498/4A



Pb Wet, Gel Dry, Agm



014980108 ~~£ 308.00~~ **£ 154.00**

1498/8A



Pb Wet, Gel Dry, Agm



1498/2A 1498/4A 1498/8A

Power supply voltage	220V-240V	220V-240V	220V-240V
Frequency	50-60 Hz	50-60 Hz	50-60 Hz
Rated current (Min-Max)	1 Amp	1-4 Amp	2-8 Amp
Battery voltage	12V	6V/12V	12V
Battery capacity	2Ah-40Ah	4Ah-80Ah	5Ah-160Ah
Degree of protection	IP65	IP65	IP65
Battery type	Lithium Wet-Gel Dry-AGM	Wet-Gel Dry-AGM	Wet-Gel Dry-AGM

014980102 ~~£ 192.00~~ **£ 96.00**

1498/2A



LiFePO4 LITHIUM

Pb Wet, Gel Dry, Agm

Electronic multipurpose battery charger, 12-24V

- Backlit graphic display
- Charging and maintenance
- Protected against polarity reversal, short circuits
- 9 charging stages
- Floating system
- Battery recovery function
- Clamp holder
- Reclining fixing hook
- Supplied accessories: cable with clamp



014980125
1498/25A £ 750.00 **£ 375.00**

- Maximum continuous charging current: 25A
- Funzione SHOW ROOM (13,8V - 21A)
- Funzione SUPPLY (14V - 21A)
- Memory saving function (13.8V - 21A)

014980126
1498/16A £ 661.00 **£ 331.00**

- Max. charging current: 16A, continuous
- SHOW ROOM function (13.8V - 12A)
- SUPPLY function (14V - 12A)
- Memory saving function (13.8V - 12A)

	1498/16A	1498/25A
Power supply	220-240V	220-240V
Power	240W	390W
Charging current	4-16A	5-25A
Battery type	Agm - Wet - Lithium (LiFePo4)	Agm - Wet - Lithium (LiFePo4)
Charging capacity	5-360Ah	5-550Ah
Maintenance capacity	5-550Ah	5-800Ah
Output voltage	12-24V	12-24V
Minimum battery voltage	0,8V	0,8V
Protection degree	IP20	IP20
Dimensions	260x130x75 mm	260x130x75 mm



014980480
1498/12 £ 883.00 **£ 442.00**

Portable car starter, 12V

- Pickup current: 2200 A
- Sealed lead acid battery, solid electrolyte (AGM) type



014980490
1498/24 £ 1,745.00 **£ 875.00**

Portable car and commercial vehicle starter, 12-24V

- Pickup current: 4200 A (12V), 2100 A (24V)
- Sealed lead acid battery, solid electrolyte (AGM) type



Portable high-performance starter, ultralightweight

The microprocessor provides total protection against:

- polarity reversal
- short circuits
- incorrect voltage
- overloads
- underdischarge
- overcharge
- overtemperature



CE 12-24V

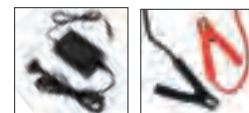

014980014
1498LT/12-24 £ 2,550.00 **£ 1,280.00**

- Up to 10,000A in 5 kg weight
- Cable length 160 cm
- Cable section 25mm²
- Automatic power supply 4 Amp



Operating voltage	12/24V
Continuous amperage	2000/1000 A
Maximum pickup amperage	5000/2500 A
Peak amperage	10000/5000 A
Clamp amperage	1000 A
Cable length	1600 mm
Battery type	4 cells LifePo4
Memory saving function	Yes
Dimensions	350x240x140 mm

959

T-handle spark plug wrenches with swivelling sockets, standard series

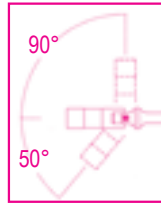

ISO 11168

	mm - "	Ø mm	L mm	g		£
959 14	14 9/16	18,8	483	440	009590009	£ 65.50 £ 33.00
959 16	16 5/8	21,4	483	650	009590010	£ 69.00 £ 34.50
959 20,8	20,8 13/16	27,0	527	960	009590011	£ 96.50 £ 48.50

957

T-handle spark plug wrenches with swivelling sockets

- Ball joint rotates 35°.
- Wrench can be used at an angle of 90° in fixed position, turning swivelling end.
- Sliding handle can be used in required position.
- Sliding handle with two catches preventing it from being accidentally pulled out.
- A retaining spring in inlet grips on spark plug hexagon.
- A rubber insert protects spark plug ceramic.

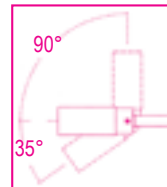

ISO 11168

	mm - "	Ø mm	L mm	g		£
957 16	16 5/8	21,4	275	440	009570000	£ 61.00 £ 30.50
957 20,8	20 13/16	27,0	275	340	009570001	£ 72.50 £ 36.50

009600031

960T/C11

~~£ 298.00~~ **£ 145.00**

Assortment of sockets for removing/installing sensors

Kit contents:

- 1 double ended hexagon socket, size 1" - 11/16" for oil pressure sensors
- 1 open end hexagon socket, 29 mm, for oxygen sensors
- 1 open end bi-hex socket, 27 mm, for injectors
- 1 open end hexagon socket, 22 mm, for vacuostats
- 1 open end hexagon socket, 22 mm, 80 mm long, for oxygen sensors
- 1 open end hexagon socket, 22 mm, 90 mm long, for oxygen sensors
- 1 open end hexagon socket, 22 mm, compact, 30 mm long, for oxygen sensors
- 1 open end hexagon socket, 22 mm, compact, 50 mm long, for oxygen sensors
- 1 open end hexagon and bi-hex socket, 22 mm, compact, 34 mm long, for oxygen sensors
- 1 open end hexagon socket, 22 mm, tube-shaped
- 1 tap M18x1.5



330x270x25 mm



38"

12"

009600055 ~~£ 111.50~~ **£ 56.00**
960/C6

3/8" female drive hexagon sockets for removing/installing exhaust gas temperature sensors

Kit contents:

- 3 short sizes, 13, 14, 17 mm
- 3 long sizes, 13, 14, 17 mm

High strength



800 g

009600890 ~~£ 1,385.00~~ **£ 655.00**
960EPC/L

Set of tools for removing glow plug electrode face
 M8x1 - M9x1 - M10x1 - M10x1,25

Allows glow plug tip to be removed when breaks occur during disassembly and head remains stuck in cylinder.



2 kg

Long version

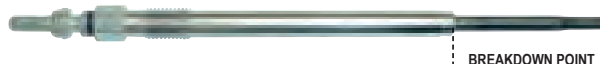

BREAKDOWN POINT

009600790 ~~£ 981.00~~ **£ 451.00**
960EPC

Set of tools for removing glow plug electrode
 M8x1 - M9x1 - M10x1 - M10x1,25

Allows end part of electrode to be correctly and quickly removed in case of breaks or seizures in glow plug seat.



900 g

Long version



BREAKDOWN POINT

009600801 ~~£ 528.00~~ **£ 264.00**
960KC-M8/M9/M10

Assortment of tools for removing broken or damaged glow plugs

FOR SPARK PLUGS WITH THREADS M8-M9-M10



2,3 kg

380x290x50 mm

009600780 ~~£ 387.00~~ **£ 194.00**

960KPC
Reversible impulse extractor with adjustable torque for glow plugs

- Pneumatic extractor with adjustable torque and special sockets allow jammed glow plugs to be unscrewed, thereby minimizing damage risk
- 5 1/4" impact sockets, long series, specially designed for glow plugs: 8-9-10-11-12 mm, 2 extensions and 1 articulated joint
- 4 adjustable driving torques: 10-20-30-40 Nm
- Right-hand and left-hand adjustment



420x185x60 mm

009600777 ~~£ 295.00~~ **£ 148.00**

960P
Pressure/depressure tester with accessories and adaptors



350x320x95 mm

009610000 ~~£ 987.00~~ **£ 494.00**

961P6
Electronic videoscope with flexible probe

Allows videos or individual images to be directly watched and recorded on instrument.

- TFT LCD 3.2" screen
- Supports SD cards and flash memories (8 GB)
- Internal memory: 64MB
- TV-OUT feature
- 4 LEDs
- Power supplied by USB port (built-in battery)



45° mirror and magnet	✓
Internal memory	64MB
TV-OUT feature	✓
Sensor pixels	640x480
Maximum resolution	320x240
Probe length	1 m
Camera diameter	6 mm
Video formats	MPEG4, 3GP, AVI, ASF.
Photo formats	JPEG
Shooting angle	0÷180°
Power supply	3,7V 2000 mAh

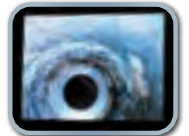

009600261 ~~£ 382.00~~ **£ 191.00**

960VTC
Leakage tester for petrol engine cylinders

After compressed air has been introduced into cylinder, gauge will allow it to be tested for compression leaks

Supplied couplers:
 M10 - M12 - M14 - M14, long

NEW



2,3 kg

373x295x71 mm



961P6/S
Flexible probes, 6 mm

	L mm		£
961P6/S1	1000	009610006	£ 448.00 £ 220.00
961P6/S2	2000	009610262	£ 447.00 £ 224.00
961P6/S3	3000	009610263	£ 508.00 £ 254.00

009600154 ~~£ 34.00~~ **£ 17.00**

960M
Socket for nozzle holder ring nuts

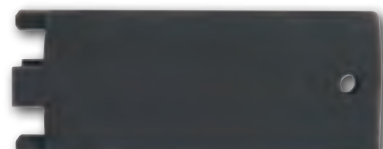

962

Tyre levers



	L mm	A mm		£
962 300	300	21	009620003	£ 26.00 £ 13.00
962 400	400	25	009620004	£ 33.00 £ 16.50
962 500	500	27	009620005	£ 42.50 £ 21.50
962 600	600	27	009620006	£ 53.50 £ 27.00

009620049

962P

~~£ 126.50~~

£ 63.00

Tyre levers with non-scratch rubber protection



009620020

962C

~~£ 153.50~~

£ 77.00

Tyre levers, pair, for cross and enduro motorcycles, mini bikes and mini dirty bikes

For use in combination with BETA 3071A and 3071B.



009630001

963

~~£ 45.50~~

£ 23.00

Pry bar with pointed and flat bent ends

• Made from alloy steel, for heavy-duty jobs

400 mm



009640001

964

~~£ 45.00~~

£ 22.50

Pry bar with pointed and leverage ends

• Made from alloy steel, for heavy-duty jobs

400 mm



009650019

965/S3

~~£ 88.50~~

£ 44.50

Set of 3 pry bars with flat curved ends

300 mm
450 mm
600 mm

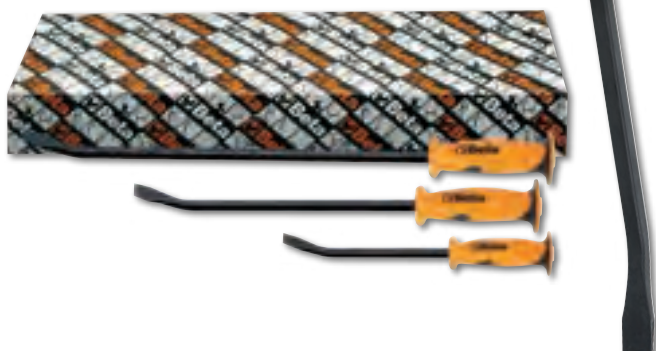

009660103

966/C3

~~£ 163.50~~

£ 82.00

Set of 3 levers with articulated, flat, curved heads

• Heads can rotate 200°
• Automatic locking of chosen position



006100125
610L/5

~~£ 212.00~~ **£ 106.00**

12"

Click-type torque wrenches with L-shaped levers, for right-hand tightening, with 5 preset values, torque accuracy: ± 4%



- Selectable torque values: 90 - 100 - 110 - 120 - 130 Nm
- Extremely quick torque selection
- When not in use, set torque to lowest value of torque wrench range

L mm	L1 mm
470	80

006100150
610L/5L

~~£ 236.50~~ **£ 118.00**

12"

NEW

Click-type torque wrenches with L-shaped levers, for right-hand tightening, with 5 preset values, torque accuracy: ± 4%



IT SUPPORTS TIGHTENING OF MOST COMMERCIALY AVAILABLE RIMS OF INDUSTRIAL VEHICLES AND SUVs.

L mm	L1 mm
470	80

- Selectable torque values: 120 - 140 - 160 - 180 - 200 Nm
- Extremely quick torque selection

007200653
720LC/C3

~~£ 44.00~~ **£ 22.00**

12"

3 impact sockets for wheel nuts, with polymeric inserts, in plastic case
○ 17-19-21 mm



148x132x44 mm



007200646
720LC/PM5

~~£ 136.00~~ **£ 68.00**

12"

Set of 5 impact sockets for wheel nuts, with coloured polymeric inserts, 1/2" drive, on magnetic guide
For use on auto lifts

○ 17-19-21-22-24 mm



009690201
969/C5

~~£ 159.00~~ **£ 80.00**

12"

Set of 5 hub nut locking sockets in plastic case

- Contents:
- 1 hexagon socket item 969A, 35 mm
 - 4 bi-hex sockets item 969B, 30-32-34-36 mm



009780001
978

~~£ 77.00~~ **£ 38.50**

009790001
979

17x19x21x22 mm

Four-way hexagon wheel nut wrenches

17x19x21x22x 1/2 mm

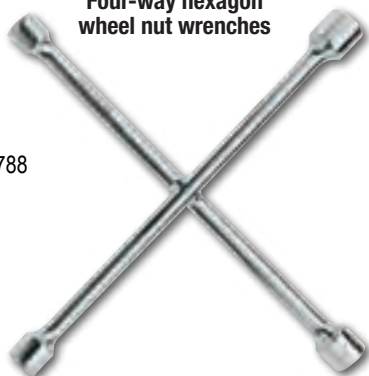

UNI/ISO 6788
DIN 3119

009720010 ~~£ 413.00~~ **£ 207.00**
972/C10

Removal kit for damaged wheel nuts

For use on anti-theft and conventional nuts



290x250x60 mm

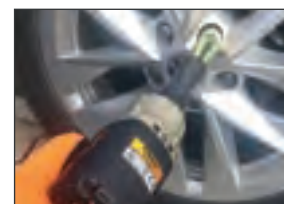

009720004 ~~£ 328.00~~ **£ 164.00**
972/C4BMW

Removal kit for anti-theft bolts with free rings, for BMW and Mini cars



516x145x66 mm



014700000 ~~£ 54.00~~ **£ 27.00**
1470FT

Drum brake shoe spring clamp pliers

- 40° angled noses
- Easy access to awkward spaces



L 184 mm

014720100 ~~£ 172.00~~ **£ 86.00**
1472AU

Drum brake shoe spring clamp pliers

- 40° angled noses
- Easy access to awkward spaces

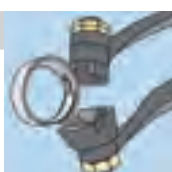

L 275 mm

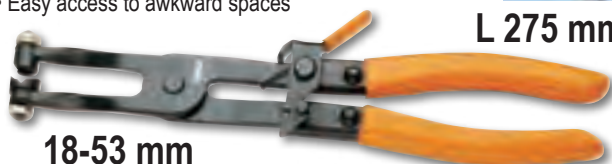

18-53 mm

014710367 ~~£ 104.00~~ **£ 52.00**
1471PT/C5

Impact socket kit for brake calipers nuts

- For cars of Volkswagen, Audi & Porsche group
- 3 10-tooth sockets: 11.5 mm - 15 mm - 20 mm
- 2 7-tooth socket: Ø 14 mm - 22 mm

12"



7-tooth 10-tooth



Ø mm	L mm
25	50

014740015 ~~£ 48.00~~ **£ 24.00**

1474DL

Spark-plug pliers, long nose, double layer PVC coated handles



014760005 ~~£ 132.00~~ **£ 66.00**

1476A

Pliers for exhaust pipe cutting



014790100 ~~£ 42.50~~ **£ 21.50**

1479LV/S3

Kit of 3 multipurpose wrecking bars, made of metal

Sizes:

- 1479LV/1: 10 x 12 mm
- 1479LV/2: 4.8 x 9.6 mm
- 1479LV/3: 2.8 x 6 mm



014790604 ~~£ 47.00~~ **£ 23.50**

1479L/K4

4 wrecking bars for jobs on dashboards and delicate parts



014790700 ~~£ 94.00~~ **£ 47.00**

1479ML/B17

Kit of 17 multipurpose wrecking bars, made of plastic. Particularly recommended for precision jobs



014790251 ~~£ 49.50~~ **£ 25.00**

1479N/S5

Kit of 17 multipurpose wrecking bars, made of plastic. Particularly recommended for precision jobs



014790603 ~~£ 15.00~~ **£ 7.50**

1479ML/S3

Kit of 3 multipurpose wrecking bars, made of plastic. Particularly recommended for precision jobs



014810312

1481/C12

£174.00

£ 87.00

Kit of 6 pairs of hose pliers

Sturdy and reliable

Kit contents:

- 2 different pairs of pliers size 1/4"
- 2 different pairs of pliers size 3/8"
- 2 different pairs of pliers size 5/16"
- 3 pairs of rubber caps



370x270x59 mm

014810200

1481PL/S3

£91.00

£ 45.50

Set of 3 plastic hose pliers

1481PL/A Ø 8÷15 mm

1481PL/B Ø 15÷25 mm

1481PL/C Ø 25÷45 mm



1481PL/A



1481PL/B



1481PL/C

014820021

1482B

£66.00

£ 33.00

Quick coupler pliers for fuel pipes



014820026

1482D

£126.00

£ 63.00

Quick coupler pliers for fuel pipes, with flexible extension



014910040

1491A

£48.00

£ 24.00

Adjustable oil filter pliers

Precision adjustment through rack



Ø min 55
Max 140 mm

014920001

1492/1

£57.00

£ 28.50

Adjustable oil filter wrenches

1492/1 Ø 60÷80 mm

1492/2 Ø 80÷110 mm

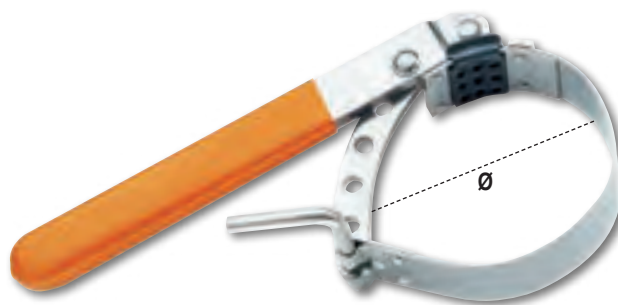

014920002

1492/2

£60.00

£ 30.00

014940150
~~£ 173.00~~ **£ 87.00**
1494/C14A **12"**

Assortment of 14 oil change tools

- 1494E 8-9-10-11-12-14-17
- 1494Q 8-9,5(3/8")-12-13
- 1494T 10
- △ 1494 9,5(3/8")
- 1494XZN M16

≡ 380x305x40 mm



014940401
~~£ 23.60~~ **£ 12.00**
1494M

Tool for hexagon oil drain plugs
 magnetic, flexible
 allows plug to be unscrewed without risking getting burnt or dirty

L	F	Ø
mm	kg	mm
293	2,5	19

SAFE, CLEAN OPERATION



014940310
~~£ 42.50~~ **£ 21.50**
1494VW/K

Engine oil replacement kit, for VAG cars
 Kit contents:
 • 1 special socket for plastic oil drain plugs
 • 6 plastic oil sump plugs



014950500
~~£ 375.00~~ **£ 188.00**
1495/C6

Assortment of tools for repairing oil sump threads
 Allows oil discharge screw threads to be quickly and easily repaired

- Damaged thread is removed by screw tap and enlarged by one size
 - Allows repairs and avoids replacing oil sump
- Contents:
- 1 screw tap M13x1.25 + 6 screws + 12 washers
 - 1 screw tap M13x1.5 + 6 screws + 12 washers
 - 1 screw tap M15x1.5 + 6 screws + 12 washers
 - 1 screw tap M17x1.5 + 6 screws + 12 washers
 - 1 screw tap M20x1.5 + 6 screws + 12 washers
 - 1 screw tap M22x1.5 + 6 screws + 12 washers



≡ 420x185x60 mm

2,1 kg

015500010 ~~£ 4,260.00~~ **£ 2,130.00**

1550U
Pneumatic shock absorber removal tool for cars, SUVs and commercial vehicles

- upper universal hold system
 - active safety system on spring
 - protective "full body" grille
- Supplied with 2 lower forks for diameters 78-205 mm
 - Maximum thrust: 2 tons (10 bars) - 1.6 tons (8 bars)
 1.2 tons (6 bars)
 - Spring compression stroke: 335 mm



MAXIMUM THRUST 2 TONS (10 BAR)



1670 mm
610 mm
825 mm

1561/...
Ball joint pullers



	L mm	A mm	Ø mm		£
1561/1	39	36,6	18	015610001	£ 86.00 £ 43.00
1561/2	47	45,7	25	015610002	£ 125.50 £ 63.00
1561/3	63	62	30	015610003	£ 158.00 £ 78.00
1561/4	75	63	40	015610004	£ 238.50 £ 119.00

015550006 ~~£ 1,093.00~~ **£ 545.00**

1555Q
Compressor for MacPherson and equivalent shock absorber springs
Maximum thrust: 1500 kg

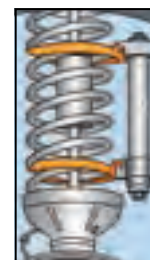
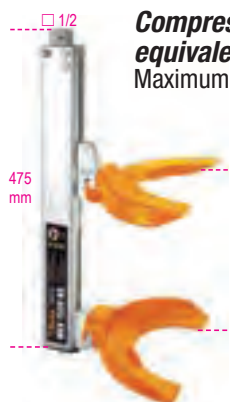

A min÷Max mm
65÷354

Ø min÷Max
80÷195

11 kg

015560101 ~~£ 305.00~~ **£ 153.00**

1556/1A
Compressor for shock absorber springs



2,8 kg

min L Max mm
65÷320

015560102 ~~£ 298.00~~ **£ 149.00**

1556/2A
Compressor for shock absorber springs

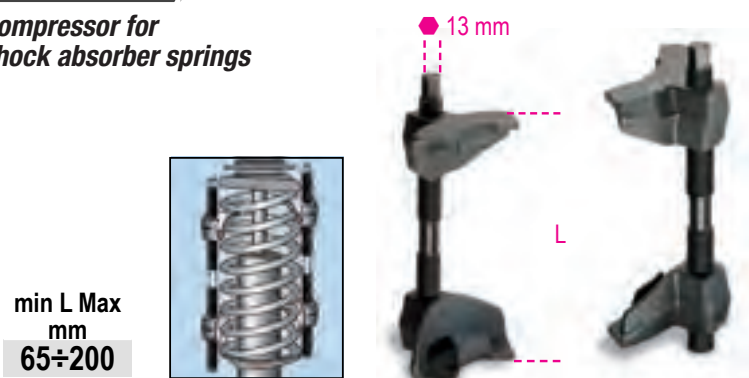

min L Max mm
65÷200

1569CP

Striking tools for installing conical bearings and oil seals
Quick adjustment



	Ø min÷Max mm	L mm		£
1569CP/50	9,5÷50	130	015690750	£ 186.50 £ 93.00
1569CP/90	18÷90	145	015690790	£ 235.00 £ 118.00

016000010 ~~£ 54.00~~ **£ 27.00**
1600Q 10

Eight-way wrench, with articulated joint, for control panel operators

- Eight-way wrench, can be rotated to easily select the head to use.
- Magnetic articulated joint for increased force.
- 1/4" male drive for use of sockets.



Wrench for maintenance in numerous sectors, including electrical industry, plumbing, ventilation and gas.

017610130 ~~£ 155.50~~ **£ 78.00**
1761RS/1

Reversible wire twisting pliers with automatic return



L 220 mm



017660100 ~~£ 608.00~~ **£ 304.00**
1766/8

Assortment of 8 tools for car glass windows

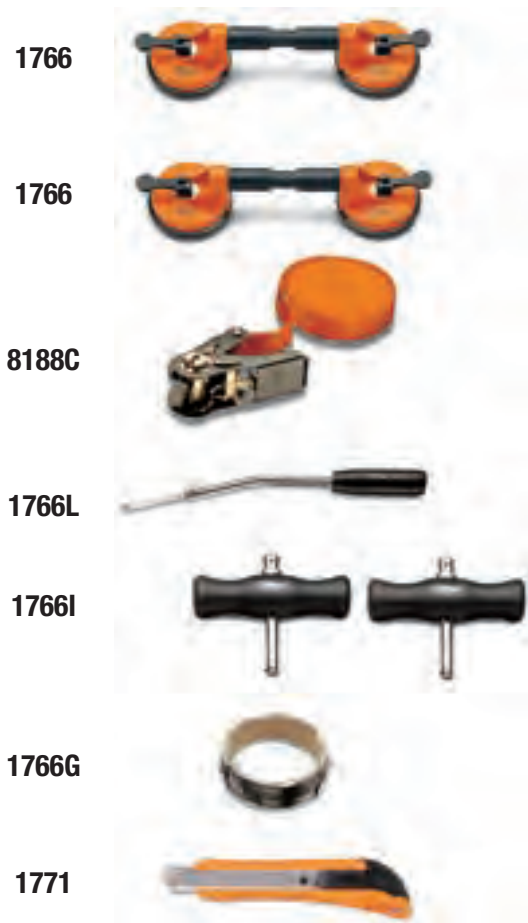

017670100 ~~£ 204.50~~ **£ 102.00**
1767B

Pedal and steering wheel locking kit

The trigger adjustment mechanism ensures accurate settings when keeping the vehicle accelerated



2,4 kg

90x285x95 mm

017670020 ~~£ 26.00~~ **£ 13.00**
1767PMC

Magnetic tool holder, round

Ø 150 mm



017670010 ~~£ 64.00~~ **£ 32.00**
1767PMR

Magnetic tool holder, rectangular



365x165 mm



022580011 ~~£ 263.00~~ **£ 132.00**

2258-0

Heavy duty creeper with tool chest

- Overall height: 450 mm
- Front tote-tray
- Rear tote-tray with partitions
- 4 pivoting castors



3 drawers with ball bearing slides (320x195x60 mm)

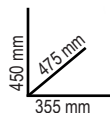

kg
130

kg
10,2

022540047 ~~£ 36.50~~ **£ 18.50**

2254T

Kneeling pad

Made from non-slip EVA foam



kg
200 g

030000210 ~~£ 238.00~~ **£ 115.00** **NEW**

3000L

Creeper

- PVC lining with upholstered foamed rubber designed for remarkable comfort



kg
110

030020001 ~~£ 140.50~~ **£ 70.00**

3002

Creeper and seat

- Steel frame
- PVC lining with upholstery
- Easily convertible into a creeper or a seat

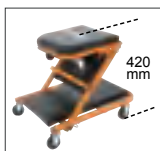

420 mm

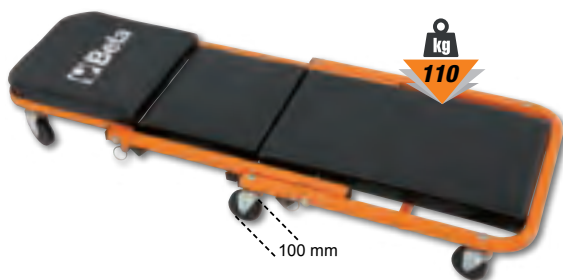

kg
110

100 mm

030030001 ~~£ 102.00~~ **£ 51.00**

3003

Creeper made of shockproof plastic

- Wheel Ø: 76 mm



kg
110

kg
5

120 mm

030030100 ~~£ 341.00~~ **£ 171.00**

3003C

Creeper made of shockproof plastic

- Complete with:
 - head and lumbar region with carbon look finish
 - upper metal plates for fixing magnetic accessories
 - 6 rubber castors, 79 mm in diameter
 - Max. capacity: 120 kg

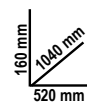

kg
120



030030150 ~~£ 484.00~~ **£ 240.00**

3003PRO

Creeper made of shockproof plastic

- ergonomic head cushion
- soft back protector
- 2 178 mm double bearing castors for trouble-free use on uneven surfaces and pipes/cables
- 1 castor
- double height adjustment from the ground: 38 or 76 mm
- 2 portable LED lamps (250 lumens) with fixing magnets
- load capacity: 200 kg
- weight: 7.7 kg



DOUBLE LED LAMP WITH MAGNET
DURABLE AND ERGONOMIC

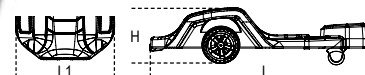

H min mm	H Max mm	L mm	L1 mm
170	230	1040	570

013670200 ~~£ 254.00~~ **£ 127.00**
1367/K10

Kit of punches for installing parking sensors
 Perpendicular, burr-free holes
 Sizes Kit contents:
 17 - 18 - 18.2 - 19 - 20 - 22.5 - 24 - 26 - 26.7 - 32 mm

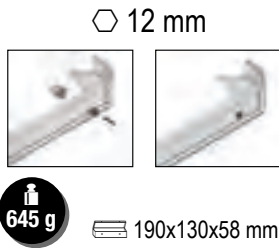

013650110 ~~£ 424.00~~ **£ 212.00**
1365P10

Oil pressure pump
 Max. 690 bar
 1.5-m-long hose,
 1/2" coupling



013660010 ~~£ 328.00~~ **£ 160.00**
1366/K5

Pneumatic dent puller, with 1.1 kg hammer face
 Heavy duty suction cups
 Kit contents:
 • 1 suction cup Ø 75 mm
 • 1 suction cup Ø 100 mm
 • 1 suction cup Ø 125 mm
 • 1 hook

610x240x90 mm



013650013 ~~£ 944.00~~ **£ 427.00**
1365/K13

Oil pressure pump, 10 t, and bodywork accessories kit in handy trolley

- Kit contents:
- oil pressure pump, 10 t, with 1.5-m-long hose, 1/2" coupling
 - piston
 - wing opening pliers; capacity: 500 kg
 - baseplate, 150x90 mm
 - L-shaped base, 50x50 mm
 - 4-point punch
 - round, knurled punch, Ø 50 mm
 - wedge-shaped punch, 43 mm
 - 240-mm-long extension
 - 450-mm-long extension
 - 475-mm-long extension
 - rubber head
 - male-to-male coupling for installing accessories



014300105 ~~£ 32.50~~ **£ 16.50**
1430/S5

Set of 5 tapered extractors for brown screws and studs, made from hardened steel in case

1430/1-1430/2-1430/3
 1430/4-1430/5



013660200 ~~£ 111.50~~ **£ 56.00**
1366A

Dent puller with kit of 19 plastic glue tabs

- Ideal for removing:
- Hail dents
 - Dents caused by doors
 - Small dents in general



013610030 ~~£ 395.00~~ **£ 198.00**
1361/K9

Kit of 8 levers for bodywork dent pullers

- Kit contents:
- round ball head rod, Ø 31 mm, length 110 cm
 - tip rod, length 62 cm
 - whale tail tip rod, length 112 cm
 - hook tip rod, length 27 cm
 - flat round head rod, length 50 cm
 - round ball head rod, Ø 19 mm, length 52 cm
 - whale tail head rod, length 27 cm
 - round whale tail head rod, length, 28 cm
 - fabric bag with handles

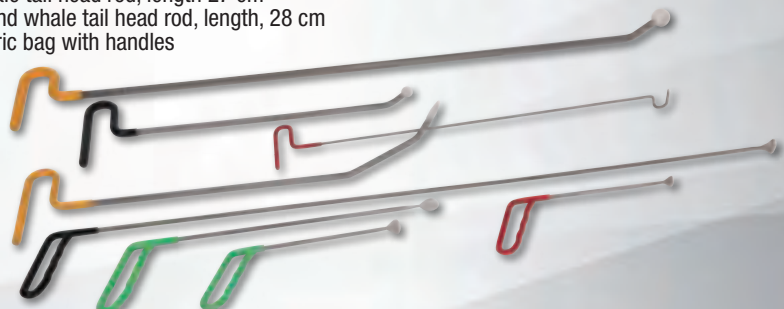

014350002 ~~£ 172.00~~ **£ 86.00**
1435/1

Eccentric stud extractor

• An eccentric knurled wheel locks slightly projecting screw, thereby allowing operation.



Ø mm 19÷26

014350001 ~~£ 124.50~~ **£ 62.00**
1435

Eccentric stud extractor

• An eccentric knurled wheel locks slightly projecting screw, thereby allowing operation.
 • Double hole for an enlarged field of use for tool.



Ø mm 4÷20

014330311 ~~£ 275.00~~ **£ 138.00**
1433/C11

Set of 11 roller stud extractors with 1/2" female square and hexagon drives in metal case with soft thermoformed tray

• A roller system works on studs in required direction (left or right) with progressive intensity

M5 - M6 - M7 - M8 - M9 - M10 - M10,5
 M11 - M12 - M14 - M16



340x135x56 mm

014100051 ~~£ 25.50~~ **£ 13.00**
1410/M

Spring pulling hook wrench

Ø mm 3,5



L 155 mm

014280111 ~~£ 342.00~~ **£ 171.00** 3/8" 1/2"

Set of pullers for damaged nuts square drive with support

8-10-11-12-13-14-15-16-17-18-19 mm



1440/...

Piston ring compressors



	Ø mm	L mm	h mm		£
1440/0	40÷75	50	140	014400000	£ 31.50 £ 16.00
1440/1	57÷125	80	250	014400010	£ 43.00 £ 21.50
1440/1A	57÷125	100	300	014400011	£ 48.50 £ 24.50
1440/2	90÷175	80	270	014400020	£ 51.50 £ 26.00
1440/2A	90÷175	100	300	014400021	£ 55.50 £ 28.00
1440/3	90÷175	165	500	014400030	£ 82.50 £ 41.50

014450001 ~~£ 46.00~~ **£ 23.00**
1445/1
 50-100 mm

Piston ring expanders

90-150 mm



014450002 ~~£ 60.50~~ **£ 30.50**
1445/2

014760002 ~~£ 102.00~~ **£ 51.00**
1476

Adjustable self-locking pliers for exhaust pipe cutting



Ø min 19 Ø min Max 75 L 225

017610101 ~~£ 84.00~~ **£ 42.00**
1761

Wire twisting pliers with automatic return



014790001 ~~£ 31.00~~ **£ 15.50**
1479

Trim pin remover



175 mm

285 mm

7381N

£ 215.00

£ 108.00

NEW

**Water resistant EXTREME
0-GRAVITY work shoes**

- Composite toe cap
- Waterproof, with bootie membrane, windproof, highly breathable
- Wide fit

EU	UK	
38	5	073810038
39	6	073810039
40	6,5	073810040
41	7	073810041
42	8	073810042
43	9	073810043
44	10	073810044
45	10,5	073810045
46	11	073810046
47	12	073810047
48	13	073810048

S3 HRO SRC WR



500 g



7372B

£ 171.00

£ 86.00

NEW

**0-Gravity woven fabric shoe,
ultralightweight, hard-wearing
and ultrabreathable**

- Heel stability support, traditional lacing
- Wide fit

EU	UK	
38	5	073720038
39	6	073720039
40	6,5	073720040
41	7	073720041
42	8	073720042
43	9	073720043
44	10	073720044
45	10,5	073720045
46	11	073720046
47	12	073720047
48	13	073720048

S1P HRO SRC



450 g



7214G

£ 109.50

£ 55.00

**Action nubuck shoe,
water-repellent,
with anti-abrasion insert
in toe cap area**

NEW

EU	UK	
35	2,5	072140235
36	3,5	072140236
37	4,5	072140237
38	5	072140238
39	6	072140239
40	6,5	072140240
41	7	072140241
42	8	072140242
43	9	072140243
44	10	072140244
45	10,5	072140245
46	11	072140246
47	12	072140247
48	13	072140248

S3 SRC ESD



500 g



7818CM

£ 108.00

£ 50.00

NEW

**Work trousers, multipocket style,
hard-wearing, comfortable and practical,
with unique camouflage design.**

- T/C canvas, 65% polyester, 35% cotton, 260 g/m²
- Stretch fabric inserts, 90% nylon, 10% spandex; 260 g/m²
- Knee pad pockets and leg bottoms reinforced in polyester 300D



STRENGTH

The polyester and cotton fabric is synonymous with hard-wearing trousers. The addition of abrasion-resistant inserts on the knees and leg bottoms translates into further increased strength.

COMFORT AND CONVENIENCE

The addition of stretch inserts in inside legs and on the back results in remarkably comfortable trousers. Accurate details and addition of pockets, ruler pocket and hammer loop, ensuring unique convenience for the most demanding workers.



MAXIMUM	
XS	078180300
S	078180301
M	078180302
L	078180303
XL	078180304
XXL	078180305
XXXL	078180306

7320NA

£ 108.50

£ 54.00

**Nubuck shoe, water-repellent,
with anti-abrasion reinforcement
in toe cap area**

EU	UK	
35	2,5	073200435
36	3,5	073200436
37	4,5	073200437
38	5	073200438
39	6	073200439
40	6,5	073200440
41	7	073200441
42	8	073200442
43	9	073200443
44	10	073200444
45	10,5	073200445
46	11	073200446
47	12	073200447
48	13	073200448

S3 SRC



095930200 ~~£ 229.50~~ **£ 115.00**
9593S

Smartwatch, touchscreen, fitness tracker, silicone strap

Supports Bluetooth 4.0, Android 4.5 and later versions or iOS9.0 and later versions; monitors heart rate, blood pressure, blood oxygen; multi-sport mode, step, distance and calorie tracker.



095470100 ~~£ 100.00~~ **£ 50.00**
9547T

"Kinder trolley", tool trolley for children from 3 years of age, complete with tools



095480120 ~~£ 820.00~~ **£ 410.00**
9548KB 20

Atala® 20" children's mountain bike

- Hi-Ten Tig 20" steel frame
- 30-mm suspension fork
- Shimano Tourney RD-TY21SS 6V derailleur
- Aluminium V-brakes
- 36-hole aluminium rims
- Colour: fluorescent yellow/matt blue



095630050 ~~£ 227.50~~ **£ 114.00**
9563G

Office armchairs, for guests

Ergonomic office chair with a sporty look, resulting from orange/black colour and captivating design.

Specifications:

- Ergonomic back
- Covered in PU imitation leather, easy to clean
- Thick high-density sponge padding for maximized comfort
- Seat height can be adjusted by a gas lift
- Curved padded armrests
- PU castors suitable for hard floors
- Maximum weight capacity: 120 kg



095490072 ~~£ 51.50~~ **£ 26.00** **NEW**
9549SBW

Wireless Bluetooth 5.0 speaker, portable, 6 functions, compact and durable, making it easy for you to listen to your favourite music at any time.

FUNCTIONS:

- Bluetooth play
- TF card play
- USB play
- audio 3.5 mm jack
- FM radio
- call function

TECHNICAL SPECIFICATIONS:

Bluetooth version: 5.0
 Wireless range: 10 m
 Battery life: 12 h

Subwoofer diameter: 12.5 cm
 Audio output mode: surround sound



NEW

Work rucksack, multipocket style, practical and capacious, ideal for both work and free time.

- rucksack with 3 compartments, each with waterproof exterior zip
- first compartment with PC pocket
- padded top handle
- USB port



34x18x52 cm



Beta

Fabio Quartararo
2023 MotoGP
World Championship



Partnership 2023

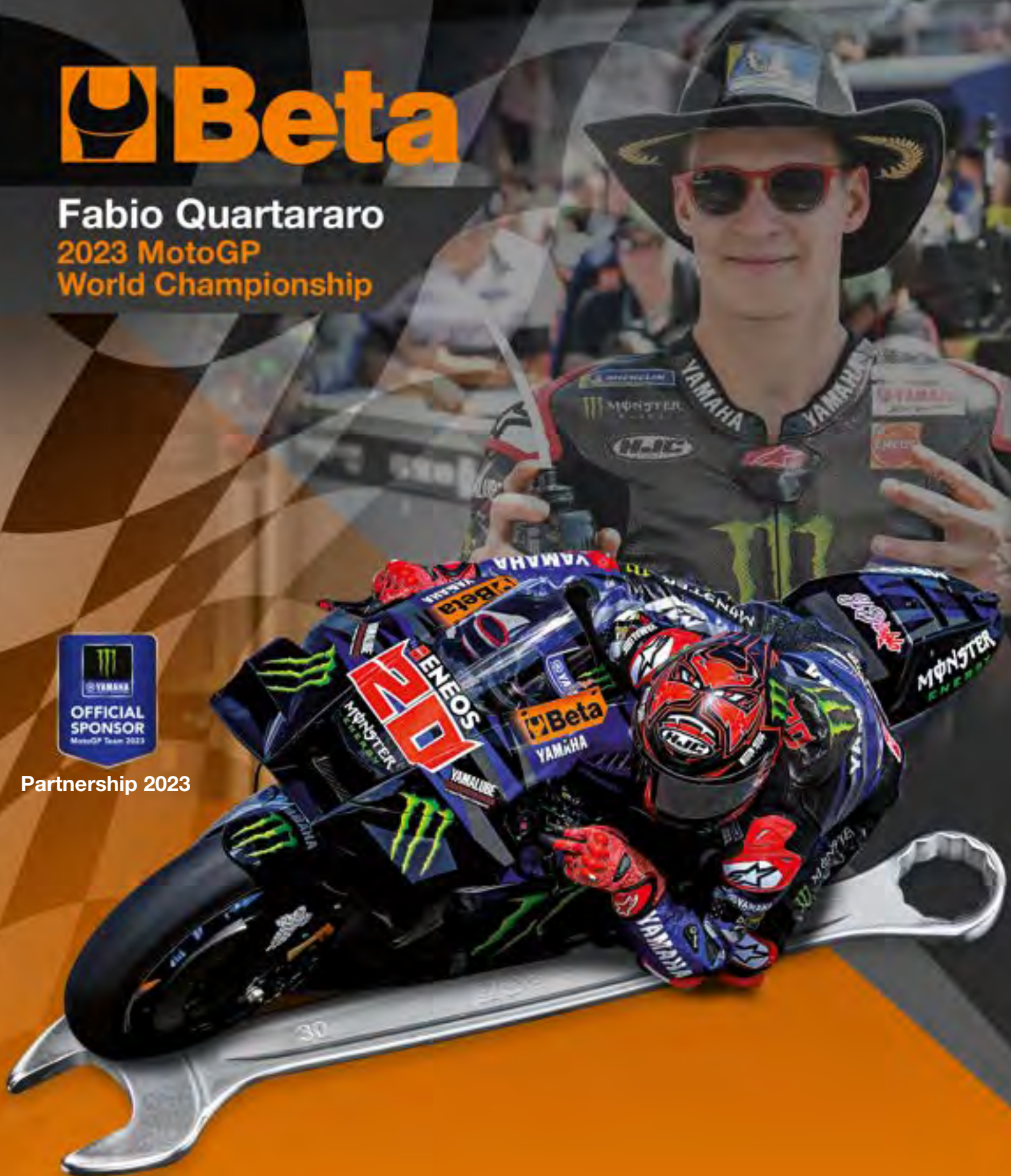

998015913



8

Beta Tools (UK) Limited | Unit D - Horton Enterprise Park
Hortonwood 50, Telford | Shropshire, TF1 7GZ
Sales: Tel. (01952) 677977

www.beta-tools.co.uk | sales@beta-tools.com

The images are for reference only. Beta Utensili S.p.A. reserves the right to update and upgrade its product range without notice.